

ESRF Newsletter

The ESRF shakes hands with industry



Editor: Montserrat Capellas Espuny
European Synchrotron Radiation Facility, BP220,
F-38043 Grenoble cedex; tel: +33 476 88 26 63;
e-mail: press@esrf.fr

Editorial committee: Nick Brookes, Dominique
Cornuéjols, Pascal Elleaume, Andreas Freund, Axel
Kaprolat, Sine Larsen, Till Metzger, Sean McSweeney,
Francesco Sette, Bill Stirling and Karl Witte

Photographers: Chantal Argoud, Montserrat Capellas,
Franck Felisaz, Peter Ginter and David Hall

ESRF Newsletter is produced for the ESRF by Institute of
Physics Publishing Ltd, Dirac House, Temple Back,
Bristol BS1 6BE, UK; tel: +44 (0) 117 929 7481;
e-mail: esrfnewsletter@iop.org; Web: iop.org

Publishing director: Richard Roe
Publisher: Jo Nicholas
Contract manager: Kerry Hopkins
Production: Kate Boothby
Technical Illustrator: Alison Tovey
Display advertisement manager: Edward Jost
Advertisement production: Teresa Honey
Product manager: Claire Webber

ISSN 1011-9310

©2005 ESRF



Contents

Editorial

- 3 The ESRF and industry

Feature news: the ESRF and industry

- 5 ESRF shakes hands with industrial users
7 Accelerating towards a cleaner future
8–9 MX beamlines provide common focal point for
industry and academia

Feature news

- 11 PSB moves into its new home
12 New treatments preserve a 460-year-old
shipwreck
13 X-rays explain birth and death of molecules
14 Optics group strives to make perfect X-ray
focusing mirrors
15 New Spanish beamline gets going

Interview

- 16–17 Irene Margiolaki: on the right path

Scientific highlights

- 18 Characterization of the H₂ sensing mechanism
of Pd-promoted SnO₂ by XAS in operando
conditions
19 Structure of bacterial tubulin BtubA/B:
Evidence for horizontal gene transfer
20 Aggregated diamond nanorods, the densest
and least compressible form of carbon
20 BM20 - In situ X-ray diffraction studies
concerning the influence of Al concentration



Industry and the ESRF. A combination that works. See pp3–8.

Cover images: Robert Isear, Science Photo Library (top); Philipp Psaila, Science Photo Library (middle);
Peter Ginter (all others).

Cover concept: Richard Davies.

on the texture development during sputter
deposition of Ti-Al-N thin films

- 21 Micro and nano-rheology of polymeric
solutions using photon correlation
spectroscopy with coherent X-rays

Scientific article

- 22–23 Synchrotron radiation microtomography: a
tool for paleontology

The machine

- 24–25 ESRF's NEG coating project keeps growing

User's view

- 26–27 David Eisenberg: not an average user

Visiting a beamline

- 29 The 'anomalous' beamline – ID01

Gallery of events

- 30 ESRF students play kings for a day and show
off their work
30 Workshop gets closer to detectors
31 Nuclear resonance scattering in synchrotron
radiation celebrates 20 years
31 Coherence workshop

The ESRF and Institute of Physics Publishing have formed a new partnership to produce *ESRF Newsletter*. Institute of Physics Publishing produces *ESRF Newsletter* under contract. The ESRF provides editorial content and retains editorial control, while production, advertising sales, printing and distribution are handled by Institute of Physics Publishing. Institute of Physics Publishing is an experienced STM publisher and produces a portfolio of magazines, including *Physics World* and *CERN Courier*.



Editorial

WG Stirling, Director General

THE ESRF AND INDUSTRY

Since the ESRF's inception, collaboration with industry has been a key part of our activities. In the preamble to the Convention, signed by the representatives of the original 11 partner countries in December 1988, it was recognized that "synchrotron radiation will in future be of great significance in many fields and for industrial applications". On a number of occasions the ESRF's Council has discussed the policy to be followed on the industrial use of the ESRF's facilities. In 1995 it encouraged management to develop the industrial use of the ESRF. It also made the visionary decision that income generated in this way would be used to enhance the ESRF's potential for collaboration with industry and support the beamlines involved.

The first sale of beamtime was arranged in 1995 to allow an industrial firm to carry out proprietary research without the requirement of publication in the open scientific literature. In that year, 42 shifts were sold. The growth in this activity, and the strong interest of industry in the ESRF's beamlines, is demonstrated by the corresponding figure for 2004 of 541 shifts.

The Council returned to these issues in autumn 1998 and spring 1999, with discussions about the sale of beamtime for proprietary research, the creation of dedicated beamlines and instrumentation, and the transfer of know-how and technology. This resulted in a statement, adopted at the end of

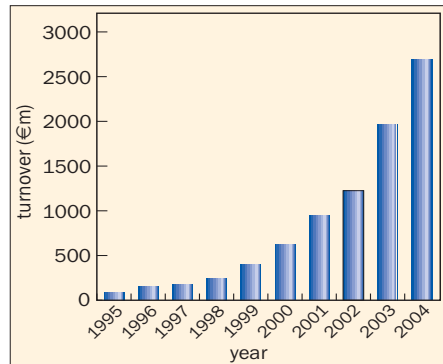

Beamtime boom. Sales in the last 10 years.

1999, which, with minor adjustments, continues to govern the interactions between the ESRF and industrial companies where beamtime sales and licence agreements are concerned. Over the intervening period there has been a sustained growth in beamtime sales (see figure).

It is misleading to consider the sale of beamtime to be the only, or most important, link with European industry. Many ESRF users have collaborative programmes with industrial partners involving synchrotron radiation experiments at the ESRF. This is fundamental research, but of a "near-industry" nature, which brings new concepts and techniques to the ESRF from industrial laboratories. We estimate that up to 20% of the scientific programme of the ESRF falls into this category.

So, overall, there are strong collaborations between industry and the ESRF. But it has not always been easy to persuade industry of the usefulness of our beamlines. What are the key factors that have led to these successful

partnerships? We have a powerful and reliable X-ray source, a set of high-performance specialized beamlines, and we offer a variety of services. Most important, our scientific, technical and administrative support staff demonstrate a high level of expertise. As a result, I believe that the ESRF offers an outstanding service to industry.

Another positive factor is our location in the Polygone Scientifique. The mixture of academic and industrial research centres – in particular, our neighbours the ILL and the EMBL – is favourable to the creation of alliances and scientific projects of interest to industry. An excellent example of this symbiosis is the Partnership for Structural Biology, a joint centre for structural biology created on our site and associating the complementary expertise of the EMBL, the IBS, the ILL and the ESRF with that of the IVMS.

A final point of importance is that of the income generated by industrial activity. What happens to the sums shown in the figure? Following deliberations at Council, these are invested in the ESRF's facilities. Half goes to the beamlines where it is generated, mainly to purchase equipment or pay for extra staff. The remainder is used to finance projects of general interest for the ESRF. All of the income is therefore reinjected into the ESRF budget to improve the beamlines and the ESRF as a whole, as decided by the Council some 20 years ago. ●



Phase Contrast Imaging

Phase contrast imaging is an extremely powerful technique for revealing the finest details hidden in soft matter and soft tissue.

The main difficulty is to reveal very subtle contrast fringes that are coming up from the contribution of the imaginary part of the absorption coefficient of the sample imaged. In practice this means working with materials with very little absorption, i.e. the smaller the contribution of the real part of the absorption coefficient the better.

Therefore those fringes are observed onto a large background, and this typically requires wide dynamic range as well as very high spatial resolution.

Those two requirements usually act against each other, and the X-Ray VHR unifies those two essential detector features in a unique camera design by delivering an optical pixel size as small as 4.5 microns with a genuine 16 bit dynamic range.

When combined with a submicron laboratory X-ray source, which limits intrinsic blurring effects from the source, we must also count on high sensitivity and very low noise acquisition. Those X-ray sources are indeed delivering low power: i.e. a few Watts at a maximum of 40kV.

Using the X-Ray VHR camera, single photon detection with its extended integration capability enables the weakest scattering samples to be now imaged on a table top phase contrast imaging configuration.

When used with synchrotron sources, having more flux available requires shorter integration periods. It is then possible to use the 100% duty cycle capability offered by the X-Ray VHR camera.

Combined with shutterless, smear free acquisition, the camera allows continuous sample rotation for 3D reconstruction. This is achieved without saturating or blooming the final image, which is important for avoiding 3D reconstruction artefacts.

Careful synchronisation is obtained with direct hardware triggering on the camera with simultaneous read out and exposure.



Plastic foam: 60kV, 2micron resolution

Diane BRAU

Marketing Communication Manager – Photonic Science Limited
Tel: +33 (0) 4 76 93 57 20 Fax: +33 (0) 4 76 93 57 22

Email: Diane@photonic-science.com
<http://www.photonic-science.com>

Advertising feature

Metals & Materials. Solutions for research and industry

Standard and custom made products in Pure Metals, Alloys, Polymers, Ceramics, as well as many Composites and Compounds in various forms including foil, rod, tube, wire, powder, etc.

All available on our secure website – and with a 5% discount!

Goodfellow Cambridge Limited
Ermine Business Park
Huntingdon, PE29 6WR
Tel: 0800 731 4653
or +44 1480 424 800
Fax: 0800 328 7689
or +44 1480 424 900

E-mail: info@goodfellow.com
www.goodfellow.com



Goodfellow

Feature news: the ESRF and industry

ESRF SHAKES HANDS WITH INDUSTRIAL USERS

Industrial users want a single contact point, a quick response to requests, fast and simple access, confidentiality, respect for deadlines, and access to new methods, technologies and know-how. The ESRF offers all of this and more.



New alliances. Collaborations between science and industry have real potential to be beneficial to both sides.

Only a maximum of 10% of the total scheduled beam time at the ESRF can be dedicated to industry for proprietary research, even if on some beamlines this percentage can go up to 30%. Nevertheless, the ESRF already has around 100 industrial users and has set up an Industrial and Commercial Unit (ICU), a bridge between the synchrotron and industry.

The excellent performances obtained progressively on different ESRF beamlines has made the ESRF a potential tool for industrial research. Industry gradually started to show interest in the ESRF. To manage industrial demands properly, the ICU was created in 2002 to link industry and scientists at the ESRF, aiming to improve relations with industry and prove that scientific excellence is perfectly compatible with business and industrial research.

The ICU is responsible for all initiatives related to the sale of beamtime and associated services, marketing, technology transfer, intellectual property, licence agreements and special collaborations, in particular contracts within the framework programmes of the European Union, currently FP6.

To pay or not to pay

For the sale of beamtime, the ICU works in strong collaboration with the Experiments Division. Scientific advice is provided to customers by the scientists of the appropriate beamlines. Researchers are also responsible for the scientific tasks necessary to assist industrial users in carrying out

their experiments. Staff involved in relations with industry are highly motivated because this represents a new activity that, as with academic users, frequently stimulates improvements on the beamlines. Currently most of the groups of beamlines are involved in industrial work.

Industrial users can have access free of charge to ESRF beamlines through the peer-review system, but they have an obligation to publish results. If they want to keep the results confidential and exploit them on a commercial basis, they can use the proprietary research mode.

Industrial users who are keen to have access to the ESRF have several options. They can come to carry out their experiments and, like academic users, they are assisted by ESRF staff for any technical aspects of their work. In addition, the ESRF can provide scientific assistance if customers require specific expertise. The most innovative option is a full service. In this case the customer sends to the ESRF, by courier, the samples to be measured and our scientists analyse them and send the results back using a secure system. This option is now frequently used on MX beamlines employing the MXpress service, and other beamlines are starting to offer a similar service. This allows customers to avoid spending time, especially nights, at the synchrotron. The principle is: "Send your samples...we'll analyse them for you." All ESRF staff involved in relationships with industry have been trained to respect confidentiality, which is the basis for mutual confidence and a fruitful collaboration.

Technology transfer

As the first synchrotron of the third-generation type built in the world, the ESRF has, over the years, made developments for its own purposes, in fields where the required equipment was not available on the market. Some developments were, or are likely to be, suitable for other synchrotron sources built subsequently, or, more broadly, for industry. Willing to share its experience with others, the ESRF set up a policy to transfer technology, aiming to turn research into innovation through collaborations with other synchrotron sources and through licence agreements. ●

MANUEL RODRÍGUEZ CASTELLANO, industry@esrf.fr



Vacuum Generators

The Worlds premier supplier for Synchrotron and High Energy Physics

- * Fixed and moveable absorbers (OFHC Copper and GlidCop for absorption of very high heat loads).
- * Fixed masks and acoustic delay lines.
- * Front end assemblies for bending magnet and insertion device beamlines including precision mechanical alignment.
- * Vacuum test, bakeout and wiring.
- * Pumping and plumbing to create girder mounting 'plug and play' front end assemblies.
- * Beam tubes and beamline vacuum vessels.
- * New range of rectangular conflat flanges.
- * Shutter and absorber assemblies.
- * Slit and mirror mechanisms.
- * X-ray goniometers.
- * 'SoftShut' and custom beamline isolation valves.
- * Valves with integral viewports (Glass, Sapphire, Be).

For your free catalogue or to discuss your Synchrotron requirements please contact us at:
Maunsell Rd, Castleham Industrial Estate, Hastings, East Sussex, UK, TN38 9NN.
tel: +44 (0)1424 851291 Email: sales@vacgen.com web: www.vacgen.com

HUBER

Diffraction and Positioning Equipment

Huber Diffractionstechnik
GmbH & Co. KG
Sommerstr. 4
D-83253 Rimsting
Germany



Let's make all SOC's as small as possible >>>

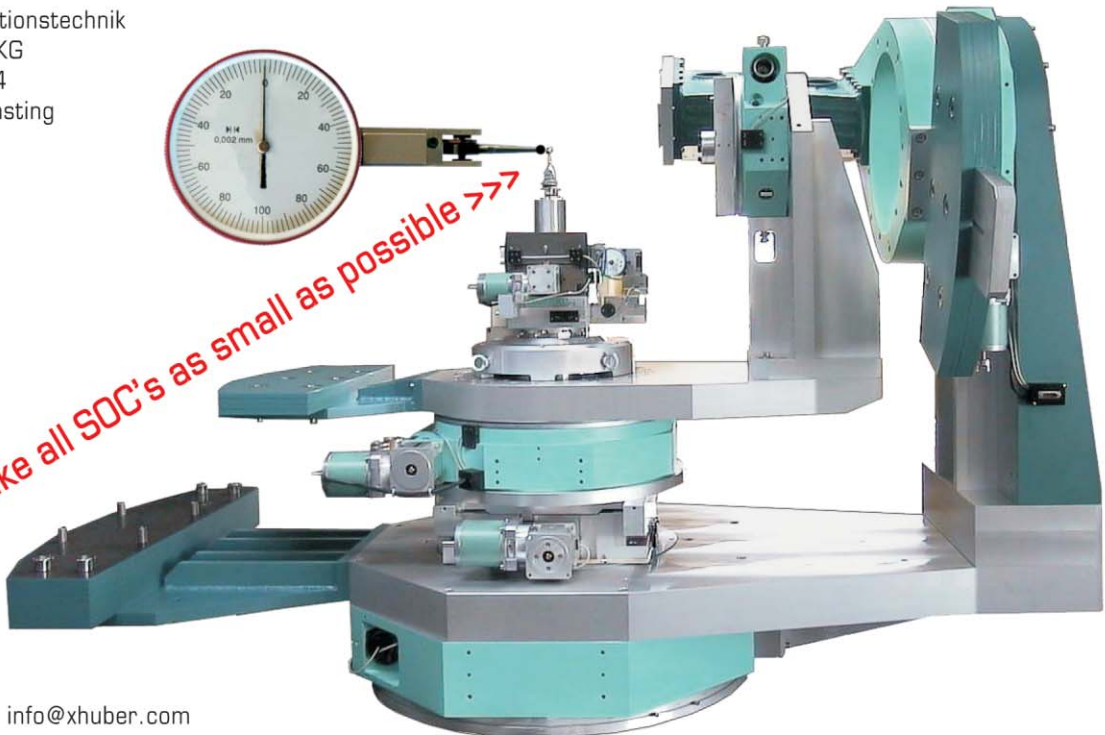

info@xhuber.com
www.xhuber.com

SOC = Sphere of Confusion

ACCELERATING TOWARDS A CLEANER FUTURE

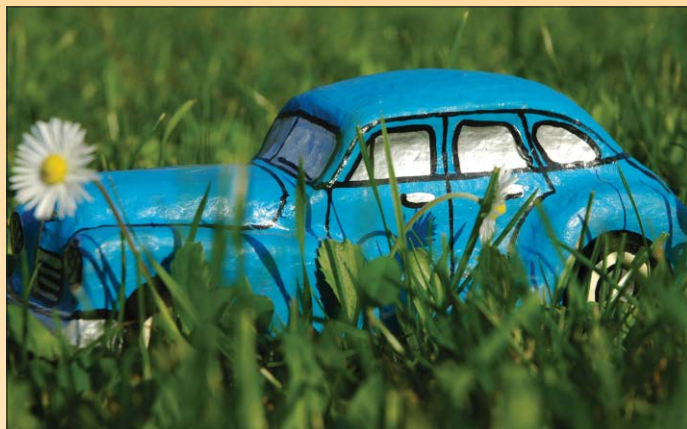

Green machines: environmentally friendly vehicles are the future.

The ESRF is an essential tool for car makers that carry out extensive research to reduce exhaust emissions.

One good example of collaboration between the ESRF and industry is the research into catalysts carried out at the synchrotron by automobile companies such as Toyota and Daihatsu. Results are confidential, but the cars that we drive today have already benefited from this sort of investigation.

If you have a look at the horizon from the top of a hill of a big city on a clear day, the sky looks not blue but grey, owing to fumes produced by pollution. The number of cars in a big city contributes, to a significant extent, to the hazy landscape of a big metropolis. Today, as a result of international environmental laws, car makers are doing extensive research to reduce exhaust emissions, and the ESRF has become an essential tool in some of their studies.

Catalytic converters transform the three main pollutant emissions (nitrogen oxides, carbon monoxide and unburned hydrocarbons) into nitrogen, carbon dioxide and water. For the last 30 years, environmental laws have become stricter in an attempt to cut down the amount of harmful vehicle emissions. Research into catalysis has therefore become essential in the automotive industry.

The study of catalysis is difficult because it is a complex process. Today, on beamline ID24 at the ESRF, real-life conditions have been simulated. Using time-resolved dispersive X-ray absorption spectroscopy, scientists work together with car manufacturers to find out what happens in the exhaust of a car when the motor is running.

Researchers place a sample in a cell connected to a gas-flow mixer that provides consecutive reductive (H_2/He) and oxidative (O_2/He) atmospheres, and to a mass spectrom-

eter. The samples are progressively heated to temperatures similar to those of catalytic converters. Changes on the catalysts' surface when they are submitted to oxidation and reduction cycles occur in less than 1 s. ID24 contains the appropriate experimental characteristics to obtain *in situ* and dynamic information about the local structure and electronic environment around the metal centre, as well as the kinetic behaviour, synchronized at the millisecond regime. This information leads to a deeper understanding of the mechanisms and kinetics of these processes, which culminate in the design of better and cleaner exhaust catalysts.

Buying staff support

The industrial research into catalysis has represented 20% of the total beamtime on ID24 in the past few years. Thanks to this, a postdoctoral researcher position is financed entirely with the income from the industrial activity. "They buy not only beamtime but also scientific and technical assistance," explained Sakura Pascarelli, who is in charge of ID24. "This collaboration has required real teamwork, where many different groups at the ESRF are involved, including the Sample Environment Laboratory, the Special Detectors Group, the BLISS, the Detector Pool and the Rapid Access Mechanics Pool," she added.

Industrial researchers are not so different from academic researchers: they come to the ESRF, collect data and then analyse it when back in their country. The difference is that they pay for confidentiality and that experiments are scheduled on demand. However, there is another difference for Sakura Pascarelli and Gemma Guilera, the "industrial" post-doc. "They come from far away because it is only here that they find the optimal experimental conditions and support for their research, and they pay for it, so you feel a bit more pressure than with academics," they said.

The ID24 team has already invested in new equipment that has increased the capacities of the beamline. For example, Mark Newton, the beamline scientist, and Olivier Mathon, the operations manager, with the help of the two beamline technicians, Sebastien Pasternak and Florian Perrin, have been involved in the installation of a new high-temperature fluorescence cell and a new fast FReLoN detector. "With these implementations, now we can reach temperatures of up to 800 °C and acquisition dwell time is reduced down to the millisecond range," said Sakura Pascarelli.

MX BEAMLINES PROVIDE COMMON FOCAL POINT FOR

The MXpress service has increased proprietary use of the MX beamlines, thereby proving to be advantageous both to the ESRF and to its academic users.

Macromolecular crystallography (MX) is a central technique for the pharmaceutical industry, which increasingly uses three-dimensional structural knowledge as a tool for the design of therapeutic agents. All of the major pharmaceutical firms now have in-house MX teams and many of the small biotech start-ups have structure-based lead compound discovery platforms.

This so-called rational approach to drug design relies on the analysis of hundreds, if not thousands, of crystal structures, each containing a potential drug molecule in a complex with a target protein.

A consequence of the pharmaceutical industry embracing this technology is that demand for access to MX beamlines at synchrotron sources for proprietary crystallographic studies has exploded and the number of companies using such facilities has trebled in the last five years.

As a result of this the ESRF introduced MXpress in 2003. This service offers pharmaceutical companies the chance

to send crystals to the beamline where data are collected and then returned for analysis. MXpress thus offers pharmaceutical companies an efficient and cost-effective alternative to the process of sending their staff to the synchrotron for a data collection that often lasts only a few hours. Initially started with 50–100 samples through a pilot study, MXpress proved to be so successful that it has expanded to the point where it services almost 20 companies with a throughput of several hundreds of samples per month.

The provision of an efficient service is one of the main driving forces for the automation of the MX beamlines. The MXpress team is a vital part of the ESRF Automation Task Force and is intimately involved in the testing of new developments under real-life conditions on the beamlines. In particular, the conception and successful implementation of the PxWeb and ISPyB databases, which are critical in the tracking of crystal samples and the subsequent reporting of results, owe a great deal to the involvement of the “industrial ladies”.

The benefits to the ESRF and its academic users of the income generated by proprietary research are also evident. These include participation in the purchase of the three

MPRESSING A SAMPLE



After a journey to the ESRF, the sample reaches the MX beamlines. Elspeth Gordon tops up the transport dewars with liquid nitrogen.



On D-day the samples are transferred to the sample changer by Stephanie Monaco. The sample changer allows her to mount and dismount the samples at cryo temperatures both reproducibly and automatically. The samples can be tested, stored and retested without sample deterioration.

INDUSTRY AND ACADEMIA

state-of-the-art ADSC Q-315 CCD detectors. These detectors, with their large surface areas, will considerably help those structural biologists studying large particles such as viruses or ribosomes

The future of proprietary research at the ESRF is looking extremely bright. The newly available microfocus ID23-2 beamline strengthens an already unparalleled range of beamlines that are available to industrial (and, let's not forget, academic) users of the ESRF. Additionally, the installation of sample changers on all of the MX beamlines and the standardization that this entails will improve both throughput and ease of use.

Finally, despite the unqualified success of the MXpress service, some companies still prefer to send staff to the ESRF to perform experiments themselves. Proposing remote control of their experiment through a Web interface might be of interest to them. Thoughts at the ESRF are already turning towards such a possibility, which would only enhance the ESRF's reputation as the "synchrotron of choice" for proprietary and academic research alike.

ELSPETH GORDON, GORDON LEONARD,
STEPHANIE MONACO



Once the sample is automatically mounted on the goniometer and centred in the X-ray beam, Monique Navizet launches data collection using the beamline control software.

Innovative Cryogenic Solutions



Research is demanding lower temperatures, higher capacities and lower vibration from traditional closed cycle cryocoolers. SHI Cryogenics Group continuous product development has produced a range of 4K cryocoolers, high capacity 10K cryocoolers and the latest advances in pulse tube technology for vibration sensitive applications.



www.shicryogenics.com

UK: 44 118 981 9373;
Germany: 49 6151 860 252

Sumitomo Heavy Industries, Ltd.
SHI-APD Cryogenics, Inc.
A Subsidiary of Sumitomo Heavy Industries, Ltd.

ULTRA FAST PCI-BASED MCA PLUS DUAL-INPUT TIME MULTISCALER **NEW!**



The Series MCA-3 MCA/MCS's boards offer far more performance for pulse-height and/or time-resolved measurements

- 8k ADC with 500 ns conversion time
- Conversion rates to 1.000.000 events/s
- Two-input multiscaler with min. 100 ns dwell time
- Up to 250 MHz count rates, up-to 512 k time channels
- Pulse-height sorting (PHA), MCS and SVA modes
- List-mode storage of PHA and MCS events
- WINDOWS 2000/XP compatible software included
- LINUX drivers optional

FOR MORE DETAILS ON THIS IMPRESSIVE LINE OF MCA'S
VISIT OUR SITE:
www.fastcomtec.com

In the USA call 831-429-5227

FAST For information contact:
ComTec GmbH

FAST ComTec GmbH, Grünwalder Weg 28a
D-82041 Oberhaching/Germany

Web-Page: <http://www.fastcomtec.com>,
e-mail: support@fastcomtec.com

Phone: +49-89-665180-50, FAX: +49-89-665180-40

PSB MOVES INTO ITS NEW HOME

The new home for the Partnership for Structural Biology is ready and staff are beginning to feel settled.

The Carl–Ivar Brändén Building (CIBB), which houses both the PSB and the Institut de Virologie Moléculaire et Structurale (IVMS), was completed and handed over to the scientific teams, as had been planned, on 10 October 2005. The ESRF scientists have quickly moved into the laboratories and have now become acquainted with their brand-new environment.

Making available a total of 2600 m² of usable laboratory and office space over four floors, the building currently houses approximately 60 researchers, which includes both postdoctoral fellows and thesis students. Within the building are some of the core technology platforms for the PSB: the ESPRIT platform screening for constructs to produce soluble protein fragments; the Isotope Labelling Laboratory, which can produce proteins that are suitable for neutron diffraction and scattering experiments and for NMR work; and the robotic high-throughput crystallization facility, which is used by a large number of teams to screen for crystallization conditions. In addition to the technology platforms, the partners operate molecular biology laboratories in the new building where the core of the ESRF structural genomics and proteomics in-house research programme is carried out.

Construction of the building and extensions to the technology platforms have been made possible partly by a European Framework Programme 6 grant of €1.7 million, which has come from the Construction of New Infrastructures Initiative. The PSB and IVMS together are both hoping to continue strongly along the European path with outreach to the scientific community, such as through Marie-Curie fellowships and a lively visitor programme. Contacts with industry are increasing and a PSB Industry Day is being planned for 12 January 2006 to raise the profile of the innovative technology and know-how of the site with commercial organizations. Both funded research collaborations and service work are areas of interest for the various partners in the PSB and IVMS.

The formal inauguration of the Carl–Ivar Brändén Building will be held on 13 January 2006 with presentations of the scientific work and technology housed in the laboratories and, of course, a tour round the building. ●

ED MITCHELL



HOME SWEET HOME

Some 10 people from the ESRF had a busy week last October moving in to the CIBB – not just their offices, but also their labs. Researchers left their science aside for a few days and were dedicated to housework. “It’s a change from normal work – after running up and down moving boxes the whole day, I am really tired when I get home,” explained Ulrike Kapp, one of the movers. But the efforts had a compensation: “It is really great to be in this new building; our lab until now was really tight, but now we will have lots of space,” said Maxime Cuypers, a PhD student in the Macromolecular Crystallography group.



Courtesy of the Mary Rose Trust

Trying to avoid wreck and ruin: one side of the ancient *Mary Rose*.

NEW TREATMENTS PRESERVE A 460-YEAR-OLD SHIPWRECK

A team of researchers provides insight into the state of a historic vessel through an analysis of the sulphur and iron composition of the timbers.

An international team has analysed the wooden timbers of the *Mary Rose*, an English warship wrecked in 1545, which was salvaged two decades ago. The team used synchrotron X-rays from the Stanford Synchrotron Radiation Laboratory (USA) and the European Synchrotron Radiation Facility (France) to determine the chemical state of the surprisingly large quantities of sulphur and iron found in the ship. These results should aid preservation efforts.

The *Mary Rose* served as King Henry VIII's principal warship for 35 years until it went down off Portsmouth in 1545. In 1982 the hull was recovered and it is now undergoing a conservation process. Magnus Sandström and his colleagues showed recently that the accumulation of sulphur within shipwrecks preserved in seawater is common by studying the Swedish warship *Vasa*, which remained on the seabed for 333 years. Their research concluded that sulphur in contact with oxygen could pose conservation problems. Over time, sulphur can convert to sulphuric acid, which slowly degrades the wood until the hull's stability is lost.

The team examined the *Mary Rose* to determine the potential threat and found about 2 tons of sulphur in different compounds fairly uniformly distributed within the 280 ton hull. To determine the sulphur species present, they first carried out experiments at SSRL. They needed to obtain complementary information to determine the precise loca-

tion of sulphur species at the micron scale, and they then came to the ESRF. By studying thin wood slices perpendicularly cut through the cell walls at X-ray microscopy beamline ID21, they found high concentrations of organo-sulphur compounds in the lignin-rich areas between the cells, which may have helped to preserve the ship while it was submerged in the seawater. This helped them to understand how accessible and reactive the different sulphur compounds found are to acid-producing oxidation.

Plenty of iron and pyrite is also present in the *Mary Rose*, which is a concern, because in the moist wood iron ions can catalyse the conversion of sulphur to sulphuric acid in the presence of oxygen. The researchers suggest that chemical treatments to remove or stabilize the remaining iron and sul-

phur compounds, and reducing humidity and oxygen access, are requirements for long-term preservation.

The *Mary Rose* Trust is already investigating new treatments to prevent acid formation. For slowing down the organo-sulphur oxidation reaction and preventing new acid formation, wood samples from the *Mary Rose* are being treated with antioxidants in combination with low- and high-grade polyethylene glycol (PEG). Another approach to slow down acid formation in PEG-treated conserved archaeological wood is to maintain it in a stable climate. It is hoped that keeping a constant low humidity of 50–55% without variations of temperature will stop changes in sulphur speciation. To maintain a stable microclimate within the wood structure a surface coating offers a possible solution, although the effectiveness of this approach has yet to be tested. "This ongoing research is considered to be an important step forward in devising improvements to the current *Mary Rose* hull treatment programme," explained Mark Jones, the ship's curator.

MC

Reference

Magnus Sandström *et al.* 2005 Sulphur accumulation in the timbers of King Henry VIII's warship *Mary Rose*: a pathway in the sulphur cycle of conservation concern *Proc. Natl. Acad. Sci. USA* 102.14165-14170.

X-RAYS EXPLAIN BIRTH AND DEATH OF MOLECULES

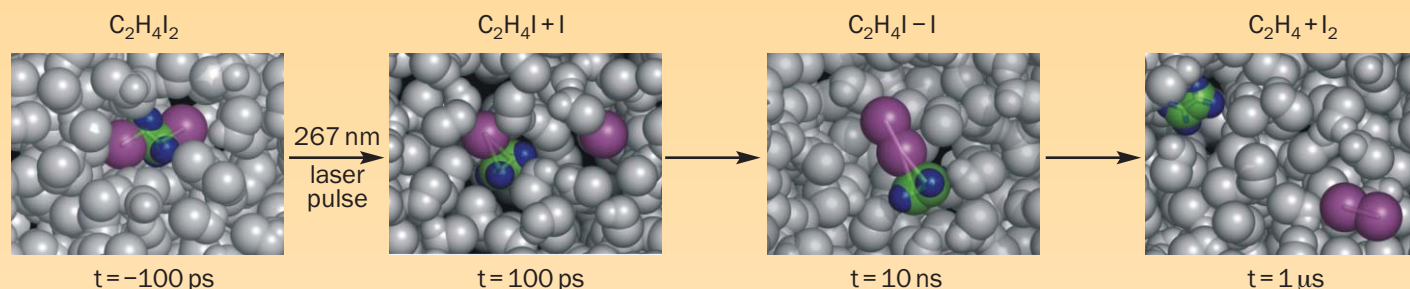

Speedy transformation: the $C_2H_4I_2$ molecule changes both in shape and composition in a very short period of time.

Researchers from Korea, Italy, France and the ESRF have observed how a molecule changes structure after being hit with a short flash of laser light. Thanks to very intense pulses of X-rays from the synchrotron, plus novel data analysis, they may be able to confirm a long-standing hypothesis on the molecule's evolution.

The experiment starts by dissolving the molecule, $C_2H_4I_2$, in liquid methanol and hitting it with a short laser pulse. This excites the molecule, which then cools down while releasing heat to the surrounding liquid. As a consequence the temperature rises and the liquid starts to expand. The absorption of light triggers a chemical reaction, which the researchers have studied with picosecond time resolution. They measured the change in shape and composition as early as 100 ps after the initial explosion, then at 10 ns, then 1 μs and so on. The dancing atoms are confined to a "dance floor" with a radius of about 0.6 nm.

Once excited, one bond in the molecule is elongated. Then the excited molecule has one of two fates. It may bounce back to the hot ground-state $C_2H_4I_2$, which is surrounded by solvent molecules. In the second case, however, the excited molecule, $C_2H_4I_2^*$, dissociates and forms C_2H_4I and I . There are two hypotheses about the structure of the C_2H_4I radical. First, the radical retains a classical structure very similar to the initial structure of $C_2H_4I_2$ (the anti structure). Second, the iodine combines with the two carbon molecules in a triangular geometry (bridge structure). This bridged conformation is the structure that prevails, according to the new measurements at the ESRF. It has long been hypothesized to explain stereochemical control, but it hasn't been observed directly until now. This research is the outcome of two years of work involving a Korean research group from KAIST, led by Hyotcherl Ihee, and the ID09B team, under Michael Wulff.

ESRF researchers had already studied the dissociation of molecular iodine some months ago and defined – theoretic-

ally and experimentally – the principal reaction channels in photoreactions in liquids. The new work is a key step forwards because $C_2H_4I_2$ is a bigger, more complex molecule than I_2 and, more important, its photoreaction proceeds through novel molecular structures that haven't been seen before.

This research opens a new door to the study of chemical reactions in liquids. Ihee believes that there is a lot of future in the technique. "We envisage expanding it to study other samples, such as nanomaterials and proteins," he said. ●

MC

Reference

H. Ihee *et al.* 2005 Ultrafast X-ray diffraction of transient molecular structures in solution *Science* **309** 1223–1227.

**Want to
place an
advert in
ESRF
Newsletter**



**If so,
contact
Ed Jost:**

**edward.jost
@iop.org**

Plane language
spoken
here.



**GRAVITY
REFERENCED**

**UP TO $\pm 80^\circ$
OPERATING
RANGE**

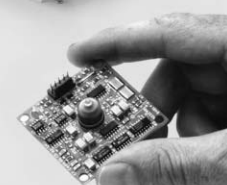

Our precision tiltmeters measure the angular position and movement of • **telescopes**
• **antennae** • **beamlines** • **foundations**
• **any machine or structure**

Available outputs include analog voltage, 4-20 mA, RS232 and RS485.

■ **500 Series** – nanoradian resolution
■ **700 Series** – microradian resolution
■ **900 Series** – 0.01 degree resolution

**APPLIED
GEOMECHANICS**

Tel 831.462.2801 USA ■ Fax 831.462.4418
applied@geomechanics.com

Did it move, or didn't it?™

www.geomechanics.com

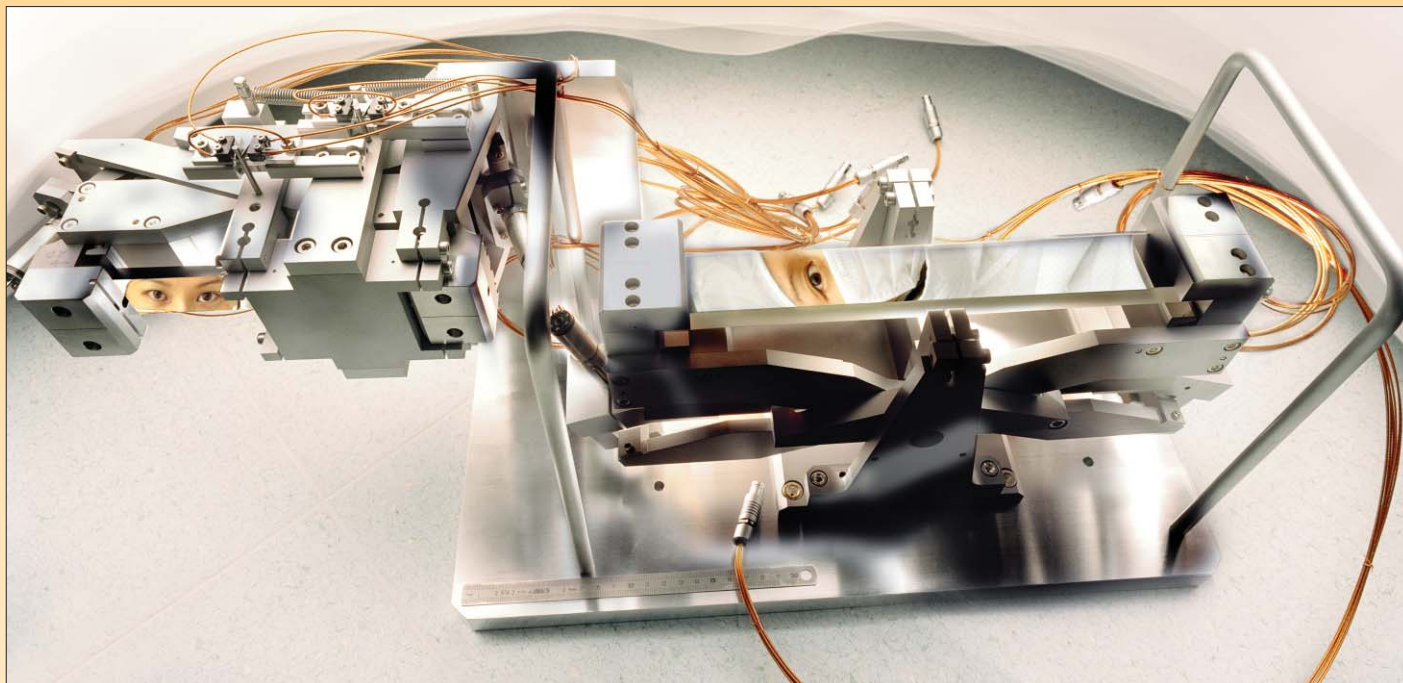

A KB system.

OPTICS GROUP STRIVES TO MAKE PERFECT X-RAY FOCUSING MIRRORS

X-ray focusing devices are crucial tools for scientists in their studies of the micro- and nanoworlds. The ESRF has therefore strongly pushed the development of Kirkpatrick–Baez systems to concentrate more X-ray intensity onto smaller spots.

Kirkpatrick–Baez (KB) mirrors are of great importance in the quest of scientists who study the nanoworld. The optics group at the ESRF is developing this focusing system so that researchers can look into their samples at smaller and smaller lengthscales.

The smallest spot size of a beam of light that can be achieved by any focusing optics is ultimately limited by the wavelength of the light: the diffraction limit. The wavelength of X-rays is a ten-thousandth the size of that of visible light, so X-rays can reveal details on the nanometre and atomic scales, which are invisible in visible light. Moreover, the penetration depth of X-rays is much superior to that of visible light and of electrons used in an electron microscope. Therefore, X-rays can provide structural information from the bulk of the samples. Mapping of strains in nanometric materials, atomic species distributions, grain sizes in alloys; the study of interfaces; the three-dimensional tomography

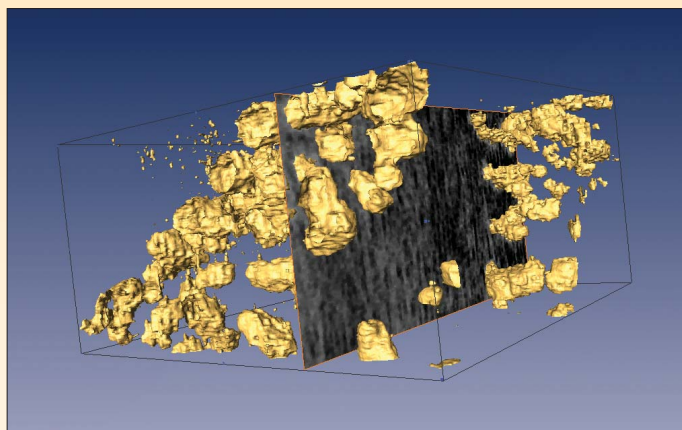

ID19 3-D tomographic reconstruction of an AlSi sample after phase retrieval was performed.

of bones, foams and snow are among the many interesting applications of X-ray microimaging, microdiffraction and microspectroscopy.

Nothing is perfect in this world, and X-ray focusing optics, such as Fresnel type and refractive lenses, curved crystals and mirrors, and waveguides, are no exception. Only a few are “perfect” in the sense that the diffraction limit dominates the technological limits, such as fabrication accuracy. At the ESRF we have concentrated on dynamically bent surfaces – crystals, mirrors and multilayers. In particular we have developed systems of two successively reflecting, orthogonal mirrors, proposed in 1948 by Kirkpatrick and Baez: the KB system. This is the method of choice to concentrate a maximum of flux into a small spot. The shaping of the two mirrors into elliptical figures is achieved by very accurate mechanical benders. The focused flux can be

strongly increased if a multilayer structure is deposited on the surface. To eliminate depth aberrations, the spacing between the bilayers must be varied along the beam footprint. Layered structures with a steep gradient can be produced with our sputtering machine. The shape and roughness of the surfaces are characterized in our metrology laboratory down to atomic dimensions.

But this is not the end of the story: the two benders must be aligned one behind the other with very high precision and stability on an antivibration support. Therefore, suitable mechanical alignment systems and control-command software have been developed to make the KB devices user friendly. Today, three basic sizes with 92, 170 and 300 mm mirror lengths can be combined to accommodate beamline specific needs, with a choice of metallic and/or multilayer coatings. Around 50 benders are installed or being built for 25 different beamlines. One example is a system of two

300 mm multilayer mirrors that accepts the full undulator beams of up to 20 keV energy and is still very efficient at 100 keV. On beamline ID19 an 80 nm spot size was achieved, both vertically and horizontally, with a record flux of 2×10^{11} photons/s at 20.5 keV.

Pushing the technique further, a line focus of 41 nm has been obtained recently at 24 keV. Temperature and vibration control become a real challenge in the nanoworld. Effective internal teamwork is absolutely essential for this development. The ESRF KB project involves about 15 people from several groups: optics, mechanical engineering and software engineering. Efforts continue to deliver more compact, stable and precise systems with nanometre surface accuracy and submicroradian angular precision. Three future "nanofocus" beamlines will fully rely on improved KB devices to discover the nanoworld. ●

OLIVIER HIGNETTE, ANDREAS FREUND

NEW SPANISH CRG BEAMLINE GETS GOING

The multipurpose Spanish Collaborating Research Group beamline at the ESRF, SpLine, obtained its first scientific data in July.

The main goal of SpLine, a bending magnet CRG beamline, is to satisfy the needs of the Spanish scientific community with a broad range of interests crossing very different research areas. Owing to this, it was decided to conceive SpLine as an interdisciplinary multipurpose beamline, which is mainly focused on materials science research.

SpLine consists of two branches, each equipped with its own focusing optics and experimental stations. Consequently, each branch can be operated independently from the other. One branch has facilities for high-resolution powder diffraction and X-ray absorption spectroscopy, while the other has facilities for single crystal diffraction, including surfaces and interfaces. The beamline has its own design, and 80% of its development has been done following its specific requirements.

The first external user at SpLine used the powder diffractometer in the first branch for the study of perovskites last summer. In the other branch, surface X-ray crystallography experiments on copper isoleucine single crystals (a metal amino-acid complex) were performed.

Next October a new diffractometer will be delivered. This is a robust 2S+3D diffractometer with a vertical main axis,



Two branches are better than one. SpLine opens its doors to users.

which can carry loads of up to 1000 kg. A UHV chamber with a high-energy photoemission spectrometer (already delivered) will be available for *in situ* combined studies of photoemission spectroscopy and X-ray diffraction.

SpLine is one of the two Spanish CRG beamlines at the ESRF. The other, BM16, which has been operational since 2003, is dedicated to macromolecular biology research and in the future also to small angle scattering. It is funded by the Spanish and the Catalan governments. ●

GERMÁN CASTRO

Interview



“After arriving at the ESRF I wanted to move on to an area outside of physics.”

Both a hobby and a job. Irene Margiolaki on ID31, the beamline where she works.

IRENE MARGIOLAKI: ON THE RIGHT PATH

She is one of the 51 postdocs at the ESRF. This young scientist arrived here two years ago after finishing her DPhil in the UK. When she arrived in France, she changed her scientific path. Now she says she enjoys her work so much that it has also become her hobby. Meet Irene Margiolaki, a Greek researcher at ID31 who always keeps a smile on her face.

Why did you change your scientific field?

My DPhil thesis was focused on the structural properties of superconducting and polymeric-fullerene-based materials, and we were using powder diffraction as the main experimental technique. After arriving at the ESRF I wanted to move on to an area outside physics. For the last two years I've been working on a methodological problem related to the use of powder diffraction as a complementary source of information in protein crystallography.

And the outcome is...

I like it. We are a growing group of peo-

ple within the ESRF together with a number of external groups coming from all over the world. We have different backgrounds, which is good because we learn from each other.

No competition?

For now we are relatively few doing this kind of research, so we try to collaborate as much as possible. When I started there were even fewer. Bob Von Dreele, who was the pioneer in this area, is a researcher from APS, and now there are more and more groups from Switzerland, France, the UK and Japan. We all have the philosophy that two minds are better than one.

Like most ESRF postdocs, you spend quite some time being a “local contact”. Doesn't it deprive you of doing your own research?

On average I do one “local contact” per month and I find it very interesting. Users come here from other countries because they have a problem that they can't solve at home. The experiments

are at the forefront of research, so I really learn a lot from our users. There's still enough time for my research. Admittedly, during experiments I end up spending a lot of hours at the ESRF.

It sounds like a not so bad deal...

It is indeed. I enjoy my work. Having the freedom to choose what to work on means that I can do what I like. You can't say that about many jobs.

“The experiments are at the forefront of research, so I really learn a lot from our users.”

You left home to go first to the UK and now to the ESRF, where you are the only Greek. How do you feel about that?

There are actually a few other Greeks here; as we say there are 10 million at home and another 10 million abroad.

I am used to living away from home and the mentality here in France is quite Mediterranean, which I like. I believe that it's the people more than the place, and having friends is important. I try to go back to Crete to see friends and family about three times a year.

So you're not going back?

Greece is a relatively small country with more scientists than academic positions, so it's not easy to get a job there. As everywhere with many able people, competition for academic posts is intense. For the moment I am happy working here. Conditions and salaries are good and there is a friendly environment. ESRF is a well structured institute with a number of people, including the beamline responsible, the head of the group and the directors, providing great support to all of us. The science you can do here is of a very high standard.

A NEW GROUP WITH GREAT EXPECTATIONS



A winning team. Left to right: A Fitch (ID31), G Fox (BM16), I Margiolaki (ID31), B von Dreele (APS) and J Wright (ID11).

The trophy, which is held by Margiolaki, is the Blue John Crystal Award, which the team received in 2004 from the British Crystallographic Association. The award was made in recognition of the group's poster, which was entitled "Synchrotron X-ray powder diffraction study of hexagonal turkey egg-white

Lysozyme." Their work showed how powder diffraction can provide valuable information about small biological samples. Many materials of interest do not readily form single crystals, so the availability of the powder technique helps to broaden the spectrum of samples that can now be characterised.

And how do you see your future?

I'd like to continue with my research,

as it's a collaboration that's just begun, so there is still a lot of work to do. ●

MC

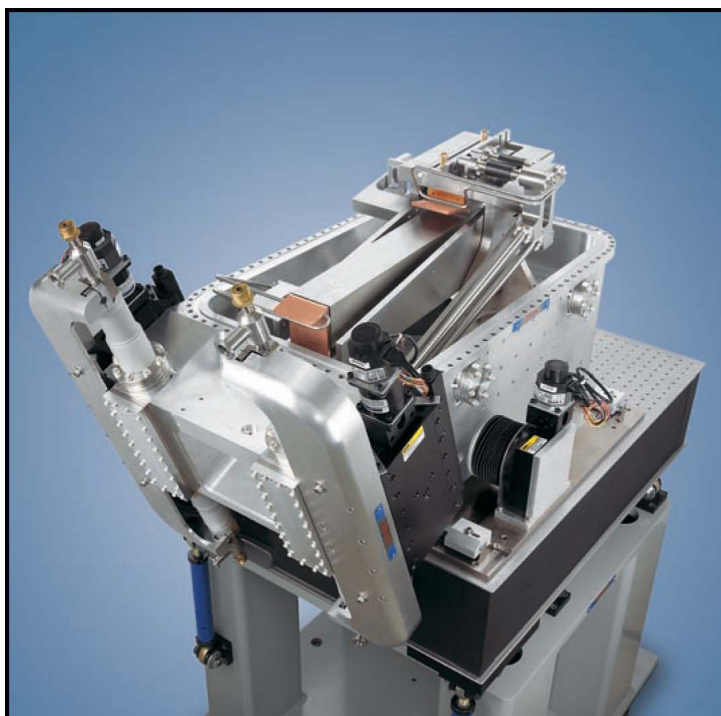

Johnsen Ultravac Inc.— the source for proven performance

Plane-Grating Monochromator

Johnsen Ultravac has been supplying corporate, national and academic research laboratories around the world with state-of-the-art ultra-high vacuum instruments for nearly 25 years.

As with everything we manufacture, our Plane-Grating Monochromator has been engineered to meet the rigorous performance standards that are critical in any synchrotron beam line application. Capable of withstanding a high heat load and with crucial energy resolution and calibration stability, our monochromator matches the most demanding design specifications with dependable accuracy, resolution and reproducibility.

For detailed information about the Plane-Grating Monochromator, or any of our other superior performance ultra-high vacuum instruments, please contact us or visit our website.

- mirror angle range = +0.5 to +5° to horizontal
- grating angel range = -0.5 to +7°
- photon energy range = 80 to 2000 eV
- Accessible in both negative and positive order.

Plane-Grating Monochromator
For soft-X-ray Beamline
*Dome lid removed

Johnsen
ULTRAVAC INC.

3470 Mainway, Burlington Ontario Canada L7M 1A8 T: 800 268 4980 or 905 355 7022 F: 905 335 3506 www.ultrahivac.com juvinfo@ultrahivac.com

Scientific highlights

HIGH RESOLUTION AND RESONANCE SCATTERING GROUP

Characterization of the H₂ sensing mechanism of Pd-promoted SnO₂ by XAS in operando conditions

OV Safonova,¹ T Neisius,¹ A Ryzhikov,^{2,3} B Chenevier,²
AM Gaskov,³ M Labeau²

1 ESRF France; 2 LMGP, Institut National Polytechnique de Grenoble, France; 3 Chemistry Department, Moscow State University, Moscow, Russia

Polycrystalline SnO₂ is the most popular material for the development of resistive gas sensors, which are used for the detection of toxic and explosive gases (CO, H₂, NO_x, etc). SnO₂ is a wide-bandgap semiconductor of the n-type. Chemisorption and redox reactions of a target gas with oxygen species that are adsorbed onto a SnO₂ surface lead to modulations of the quantity of charge and a variation in the conductivity. Metal nanoparticles (Pt, Pd) on the SnO₂ surface enhance the sensitivity to CO and H₂.

Two mechanisms to explain this behaviour are proposed: the "chemical" and the "electronic". The first addresses the ability of the nanoparticles to catalyse the combustion of the target gas; the latter considers conductance changes owing to the variation of the contact potential at the nanoparticle/SnO₂ interface, which is caused by a change in oxidation state of the nanoparticle.

The effect of Pd nanoparticles on the H₂ sensitivity of SnO₂ thin films in dynamic ("operando") conditions has been studied using time-resolved, *in situ* XAS at the Pd K- and Sn L-edges with synchronous electrical conductivity measurements and mass spectrometry. Figure 1 shows the correlation between the electrical conductance and the oxidation states of Pd and Sn (determined from the X-ray absorption edge shift) during the cycling of a Pd-SnO₂ film in H₂- and O₂-containing gas mixtures. The conductance of the Pd-SnO₂ film appears not to depend directly on the oxidation states of Pd and Sn. At the same time the amount of H₂ that participates in the reaction with the sensor material (from mass-spectrometric data) is much greater for Pd-promoted than for pure SnO₂.

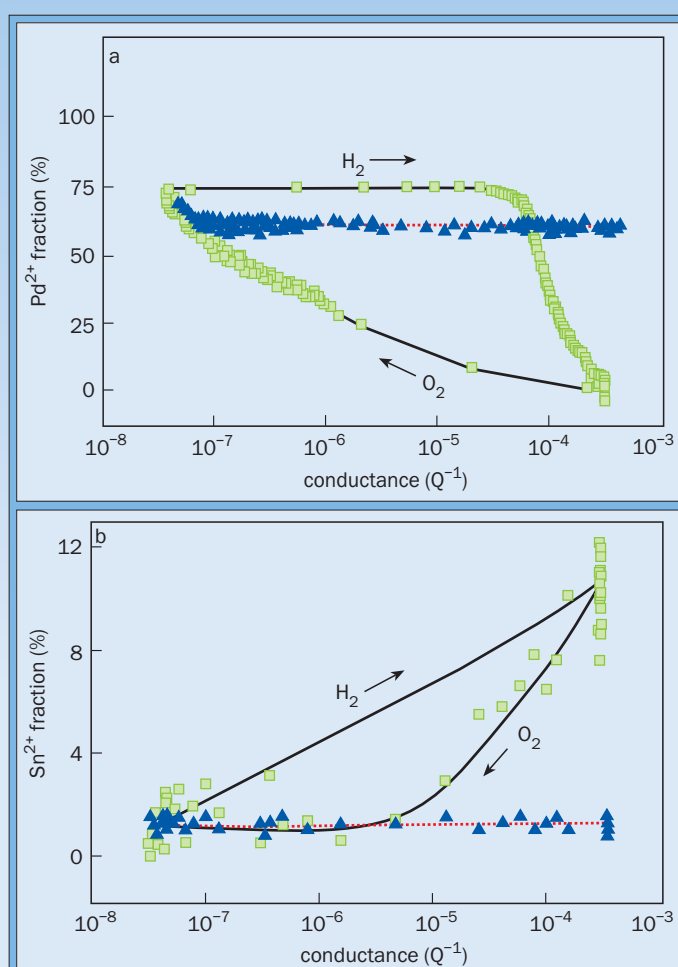

Figure 1. The correlation between the conductance of a Pd-SnO₂ film and the oxidation states of Pd (a) and Sn (b) at 573 K (white squares, solid lines) and 373 K (black triangles, dotted lines).

Based on these results we conclude that the role of Pd nanoparticles in the mechanism of SnO₂ gas sensitivity is "chemical" rather than "electronic". ●

Reference

Safonova *et al.*, 2005 Characterization of the H₂ sensing mechanism of Pd-promoted SnO₂ by XAS in operando conditions *Chemical Communications* 41 5202–5204.

MACROMOLECULAR CRYSTALLOGRAPHY GROUP

Structure of bacterial tubulin BtubA/B: Evidence for horizontal gene transfer

D Schlieper, MA Oliva, JM Andreu, J Löwe MRC-LMB, Cambridge, UK

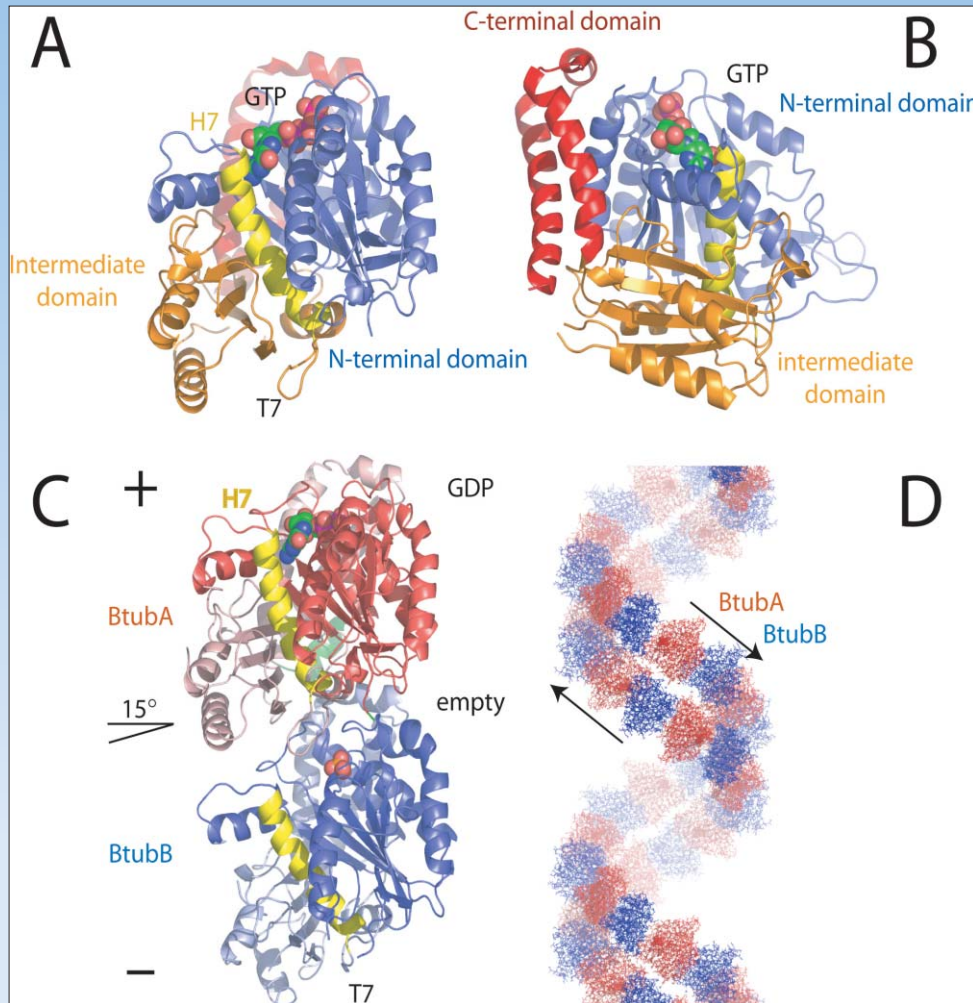

Figure 2. Crystal structures of BtubA and BtubA/B. **A:** Crystal structure of BtubA at 2.5 Å resolution. BtubA's structure is closely related to tubulin. The fold is divided into the N-terminal nucleotide-binding domain (blue), separated by helix H7 (yellow) from the intermediate domain (orange) and two large helices forming the C-terminal domain (red). **B:** BtubA contains the C-terminal tubulin domain. Shown is a view rotated 90° around the y axis from A. The two large helices (red) at the C terminal of tubulin form the outside of microtubules and make the biggest difference between tubulin and FtsZ. **C:** Crystal structure of BtubA/B heterodimer (asymmetric unit of the crystals) at 3.2 Å resolution. BtubA/B form the same heterodimer as tubulin. The protofilament axis is vertical. BtubA is situated at the plus (+) end (red) and BtubB is at the minus (-) end (blue). In the crystals, BtubA contains GDP, whereas BtubB has a sulphate ion in the nucleotide-binding site. The heterodimer is not completely straight; the two subunits are rotated by 15° around the z-axis, tangential to the microtubule wall. **D:** The BtubA/B crystals contain a continuous double filament. The 6₂₂ space group symmetry produces an antiparallel double filament with repeating BtubA/B units in the crystal packing. The bend per heterodimer is 60°, divided into 15° between BtubA and BtubB (intradimer; see C) and 45° between B and A (interdimer).

The microtubules of the cytoskeleton are constructed from $\alpha\beta$ -tubulin heterodimers. These have a complex chaperone-dependent folding pathway and are thought to be unique to the eukaryote, whereas a homologue FtsZ is found in bacteria. The exceptions are BtubA and BtubB from the bacterium *Prostheco bacter*, which exhibits higher sequence homology to eukaryotic tubulin than to FtsZ.

We could show that some of the properties of BtubA and BtubB, such as weak dimerization and chaperone-independent folding, are different from those of tubulin. However, the 3D structure of BtubA and BtubB is strikingly similar to that of tubulin. In addition, BtubA/B can form tubulin-like protofilaments [1].

Presumably, BtubA/B were transferred from a eukaryotic cell to *Prostheco bacter* by horizontal gene transfer. The high degree of similarity to the eukaryotic genes is unique within the *Prostheco bacter* genome, so we propose that at some point one or two tubulin genes were transferred to *Prostheco bacter*, where they were modified so as not to form a tight heterodimer and to fold without chaperones. ●

Reference

[1] Schlieper *et al.*, *Proc. Natl. Acad. Sci. USA* (2005) **102**, 9170–9175.

MATERIALS SCIENCE GROUP

Aggregated diamond nanorods, the densest and least compressible form of carbon

N Dubrovinskaia,¹ L Dubrovinsky,¹ W Crichton,² F Lagenhorst,¹ A Richter³

1 Bayerisches Geoinstitut, Universität Bayreuth, Bayreuth, Germany; 2 ESRF France; 3 Technische Fachhochschule Wildau, Wildau, Germany

Recently, the first synthesis of bulk samples of nanocrystalline diamond was reported. Through the use of electron energy loss microscopy (EELS), the structure of the nanometric material was identified as randomly stacked nanorods of carbon with sp³ (diamond-like) bond configuration, or, aggregated diamond nanorods (ADNRs).

Experiments conducted at the ESRF confirmed that the X-ray density of the ADNR material is greater than that of diamond by 0.2–0.4%, thus making it the densest form of carbon. Subsequent experiments, carried out by loading a diamond anvil cell with both single-crystal diamond and ADNR material, in order to compare directly their behaviour under static load, shows that ADNRs are also 11% less compressible than diamond (the isothermal bulk modulus, $K_T = 491(3)$ GPa for ADNR, compared with 442(4) GPa and 446(3) GPa for diamond) and other ultrahard materials ($K_T = 462$ GPa for Os, 420 GPa for WC, 383 GPa for Ir, 380 GPa for cBN and 306 GPa for HfN). Testing the Vickers microhardness (using a diamond indenter) showed directly that the probe tip failed to make an indentation on

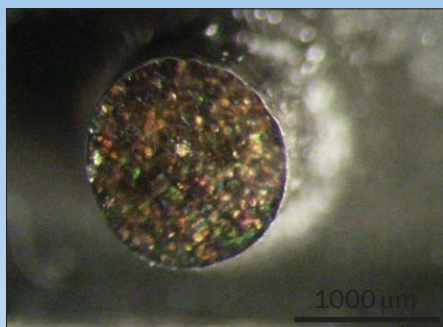

Figure 3. Stereomicroscopy image of an ADNR sample, obtained at 20 GPa and 2200 K from C₆₀ using multi-anvil apparatus at the Bayerisches Geoinstitut, Bayreuth.

the surface of the ADNR. But ADNR can scratch the (111) faces of type-IIa natural diamonds, thus ADNR is harder than natural diamond and consequently more resistant to abrasion. The random arrangement of the nanorods most probably gives rise to the increased hardness of ADNR, and the reduction in C–C bond length in the outer layers of nanorods gives rise to the increased density.

Mechanical testing has also shown that, under the same conditions, owing

to the increased resistance against graphitization, ADNR material is a much more effective grinding piece than synthetic or natural diamond, making it a potentially valuable material in machining ferrous metals and ceramics, and, owing to its nanocrystalline nature, for precision machining and polishing. ●

Reference

Dubrovinskaia *et al.*, 2005 Aggregated diamond nanorods, the densest and least compressible form of carbon *Appl. Phys. Lett.* **87** 083106.

CRG BEAMLINES

BM20 – *In situ* X-ray diffraction studies concerning the influence of Al concentration on the texture development during sputter deposition of Ti–Al–N thin films

M Beckers,¹ N Schell,^{1,2} RMS Martins,^{1,2} A Mücklich,¹ W Möller,¹

1 FZR, Germany, 2 ROBL, ESRF, France

In situ XRD was employed during the growth of thin Ti_{1-x}Al_xN films, using a deposition chamber installed at ROBL. The

films were deposited by reactive co-sputtering from titanium (Ti) and aluminium (Al) targets. In a previous experiment the substrate temperature, bias voltage and nitrogen partial pressure, and thus the growth rate, were varied at constant $x \approx 0.06$. High deposition rates of ~ 1 Å/s led to typical crossover behaviour between initial (001) and final (111)

SOFT CONDENSED MATTER GROUP

Micro and nano-rheology of polymeric solutions using photon correlation spectroscopy with coherent X-rays

A Papagiannopoulos,¹ T A Waigh,¹ A Fluerasu,²
C Fernyhough,³ A Madsen²

1 Department of Physics and Astronomy, University of Leeds, UK; 2 ESRF France; 3 Department of Chemistry, University of Sheffield, Brook Hill, UK

X-ray photon correlation spectroscopy (XPCS) can be used to follow the dynamics of matter at lengthscales of nano- to millimetres, and on timescales from nanoseconds to hours. We have used it at the Troika beamline ID10A to follow the dynamics of silica probe spheres in organic solvents.

The spheres are about 200 nm wide and yield a strong scattered signal owing to the good electron contrast. For a simple Newtonian liquid solvent the time-correlation functions $g^{(2)}(t)$ obtained by XPCS on such dilute suspensions show simple exponential behaviour $\exp(-2\Gamma t)$ with relaxation rate Γ . They can be modelled assuming the conventional Stokes–Einstein relationship with $\langle \Delta x^2 \rangle = 2Dt$, where $\langle \Delta x^2 \rangle$ is the mean square displacement (MSD) and $D = \Gamma/Q^2$ is the diffusion coefficient at scattering vector Q .

For non-Newtonian liquids a more complex behaviour of the correlation functions is observed but the MSD can still be calculated. Consequently we have used silica probe spheres to perform XPCS rheology on a biological sample – a bacterial polysaccharide (gellan) in water. Via the Laplace transform of the MSD, the real shear modulus can be found, which again can be used to construct the complex shear modulus $G(\omega) = G'(\omega) + iG''(\omega)$ by analytic continua-

off-plane preferred orientation. Reducing the rate to $<0.5 \text{ \AA/s}$ leads to a reversed behaviour with a clear (001) preferred orientation above a film thickness of 600 \AA , which is essentially independent of the substrate temperature.

Here the studies were extended to a systematic variation of x from 0 to 0.73, while keeping all other parameters constant. For an Al concentration of up to $x \sim 0.15$, the (001) preferred orientation is persistent. On the other hand, also at low deposition rates, a (111) preferred orientation can be recovered for $x > 0.15$. This can be attributed to the higher adatom mobility of Al compared with Ti in the presence of atomic nitrogen, which leads to enrichment of Al in (111) oriented grains. As a consequence, an increase of Al

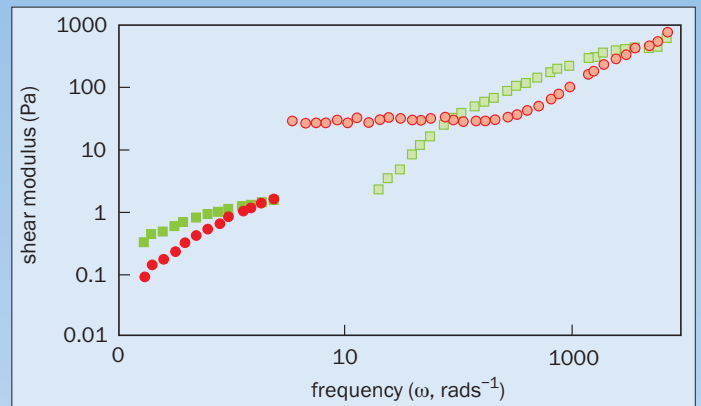

Figure 4. Complex shear modulus of aqueous gellan (G' red circles, G'' green squares). Data on a 4% solution of polystyrene sulfonate combs (G' red circles, G'' green squares) are also shown.

tion. The long elastic plateau in G' at low frequencies (circles, figure 4) is expected for gellan owing to its behaviour as a physical gel. In general, these experiments probe the zero-shear limit, which is often difficult to access with conventional active shearing techniques.

XPCS microrheology is a very sensitive technique that offers the possibility of studying optically opaque samples and measure MSDs two orders of magnitude smaller than with optical tracking techniques. ●

Reference

A Papagiannopoulos *et al.*, 2005 Microrheology of polymeric solutions using X-ray photon correlation spectroscopy *J Phys. Condens. Matter* **17** L279–L285.

towards the segregation threshold of hexagonal AlN leads to preferred precipitation in (111) oriented grains, reducing the (111) intensity and giving rise to a mixed (111) + (001) texture. Increasing the Al content even further up to $x \approx 0.60$ forces the formation of hard nanocomposite nc-TiAlN/AlN structures, and finally an Al content of $x > 0.73$ leads to dominant AlN with an a-axis off-plane texture. ●

Reference

M Beckers *et al.*, 2005 The influence of the growth rate on the preferred orientation of magnetron-sputtered Ti–Al–N thin films studied by *in situ* X-ray diffraction *J. Appl. Phys.* **98** 044901.

Scientific article

SYNCHROTRON RADIATION MICROTOMOGRAPHY: A TOOL FOR PALEONTOLOGY

P Tafforeau^{1,7}, J Baruchel⁷, R Boistel⁵, E Boller⁷, A Bravin⁷, M Brunet¹, Y Chaimanee³, P Cloetens⁷, M Feist², J Hozzowska⁷, J J Jaeger², RF Kay⁶, V Lazzari², L Marivaux², A Nel⁴, C Nemoz⁷, X Thibault⁷, P Vignaud¹

1 Laboratoire de Géobiologie Biochronologie et Paléontologie Humaine, Poitiers, France; 2 Institut des Sciences de l'Evolution, Montpellier, France;

3 Department of Mineral Resources, Bangkok, Thailand;

4 Muséum National d'Histoire Naturelle, Paris, France;

5 Laboratoire de Neurobiologie de l'Apprentissage de la Mémoire et de la Communication, Orsay, France;

6 Department of Biological and Anthropological Anatomy, Durham, USA; 7 ESRF

The aim of paleontologists is to obtain the maximum knowledge about the fossils that they study. It is therefore becoming increasingly important to have access to the internal structures of the samples. Classical techniques (mainly sawing of the fossils) exhibit at least two major drawbacks: first, they do not give access to the three-dimensional structure of samples; second, and far more important, they are destructive. Fossils are a non-renewable resource: it is often impossible to cut them to study their internal structures. Non-invasive X-ray imaging techniques overcome these problems.

Medical scanners can provide only very limited spatial resolutions. They cannot be used when precise investigations are needed. Laboratory microtomographs have evolved over the last few years and can now reach high spatial resolutions (sometimes down to a few micrometres). However, investigation of a large number of fossils remains difficult. The limitations arise principally from the polychromatic X-ray source spectrum of these machines and from the intrinsic nature of the fossils (highly mineralised samples, which often exhibit very low absorption contrast).

Using a third-generation synchrotron source optimised for hard X-rays, like at the ESRF, changes the situation dramatically. [1] Indeed, X-ray beams at the ESRF display three main properties that significantly enhance the data quality and imaging possibilities: monochromaticity, high beam intensity and partial coherence.

Monochromaticity and beam hardening

When using conventional polychromatic sources, the reconstructed slices present in many cases the so-called "beam-hardening" artefact, which is the result of the differential absorption of the X-ray spectrum by the sample. The more visible aspect of this effect is a brightening of the sample's borders.

Figure 1 shows a comparison between two scans of a fossil primate molar, the first using a conventional X-ray source and the second using a monochromatized beam (ID19). This shows that beam hardening can substantially degrade the results of μ CT investigations into fossil samples. Monochromaticity allows researchers to obtain high-quality images of important fossils, as in figure 2, which shows images of a fossil mandible attributed to the oldest known hominid from Chad, *Sahelanthropus tchadensis*. [2,3,4]

High beam intensity and spatial resolution

This type of investigation takes advantage of the high flux available from third-generation synchrotron radiation sources. Even when very-high-resolution detectors (pixel size $<1 \mu\text{m}$) are used, the intense monochromatic beam permits exposure times of a fraction of a second for a single projection. At the ESRF, through complementary beamlines, the available pixel sizes range from $350 \mu\text{m}$ (on ID17) down to 280nm (on ID19). Figure 3 shows that this range of spatial resolutions is actually needed to study a variety of fossils non-destructively. [1,3–5]

Partial beam coherence and phase-contrast imaging

Many fossils display strong chemical modifications due to diagenesis, which often lead to a very weak absorption contrast. The high coherence of the ESRF X-ray beams brings new imaging techniques based on the phase-contrast effect, which makes possible an investigation into fossils that are impossible to study using pure absorption μ CT.

Phase-contrast SR- μ CT generates 3D data with edge detection superimposed onto the absorption contrast. The amount of edge enhancement depends on several factors: on the sample-to-detector distance, on the X-ray energy, on the

resolution of the detector and on the phase properties of the sample. It reveals features that can otherwise be investigated only using microscopic slides.

One example concerns fossil teeth exhibiting either no absorption contrast or weak absorption contrast between the enamel and dentin. Numerous fossil teeth display this

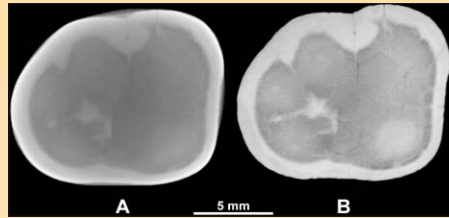

Figure 1. An industrial microtomographic slice through a fossil molar of a Miocene Thai ape (A) and (B) the same on ID19.

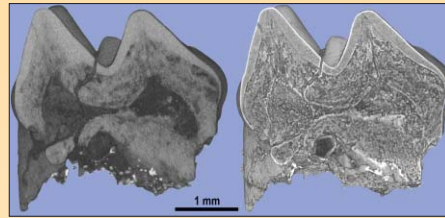

Figure 4. Comparison between absorption (A) and phase contrast (B) SR- μ CT on a fossil primate molar from Pakistan. The scans were done on ID19 with a 6.7 μ m voxel size.

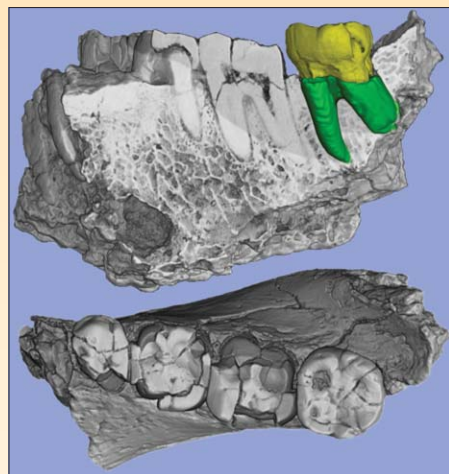

Figure 2. 3D rendering of a partial mandible of *Sahelanthropus tchadensis* on ID17 (voxel size 45.5 μ m). The third molar was virtually extracted to show the contact between the crown and the roots.



Figure 5. 3D rendering of a Cretaceous beetle from France embedded in opaque amber. The scan was done on ID19 with a moderate propagation phase contrast.

kind of mineralization. Figure 4 makes a comparison between absorption and phase-contrast scans of a fossil primate molar. Edge detection enhances the enamel–dentin junction.

Another important application of phase-contrast imaging is the investigation of inclusions in opaque ambers. Phase-contrast SR μ CT is the only technique that can provide good data about these kinds of fossils (figure 5).

Conclusion

Thanks to the potential offered by the monochromaticity, the high flux and the coherence properties, the ESRF appears to be an invaluable investigation tool for paleontologists. It allows imaging of the internal structures of a large variety of fossils with a resolution and precision that is not achievable with other non-destructive methods. The fact that it is now possible to explore the internal features of a fossil without damaging it is clearly stimulating the paleontological community to use synchrotron radiation for studying fossils of outstanding scientific importance.

References

- [1] P Tafforeau *et al.* (in press) *Applied Physics A, Materials Science & Processing*.
- [2] M Brunet *et al.* 2005 *Nature* 434 755–759.
- [3] P Tafforeau 2004 PhD thesis, Montpellier.
- [4] Y Chaimanee *et al.* 2003 *Nature* 422 61–65.
- [5] Feist *et al.* 2005 *American Journal of Botany* 92 1152–1160.

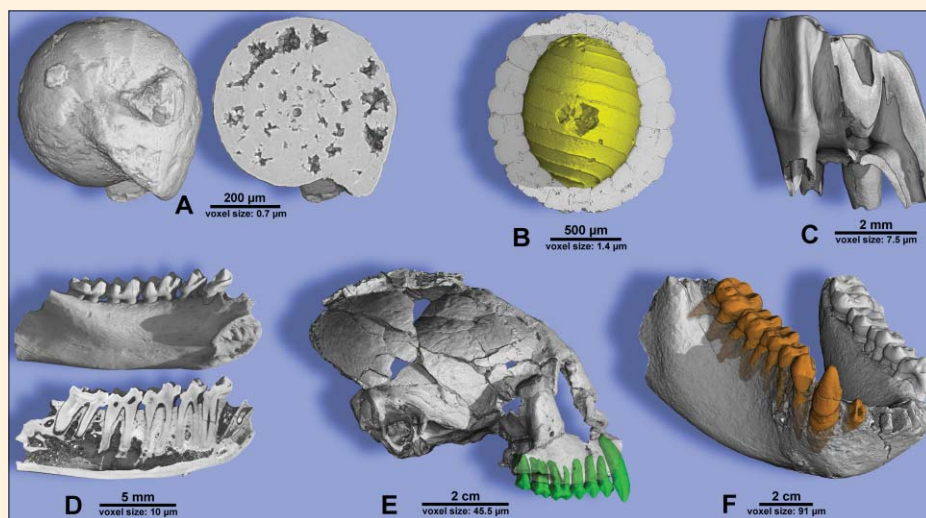
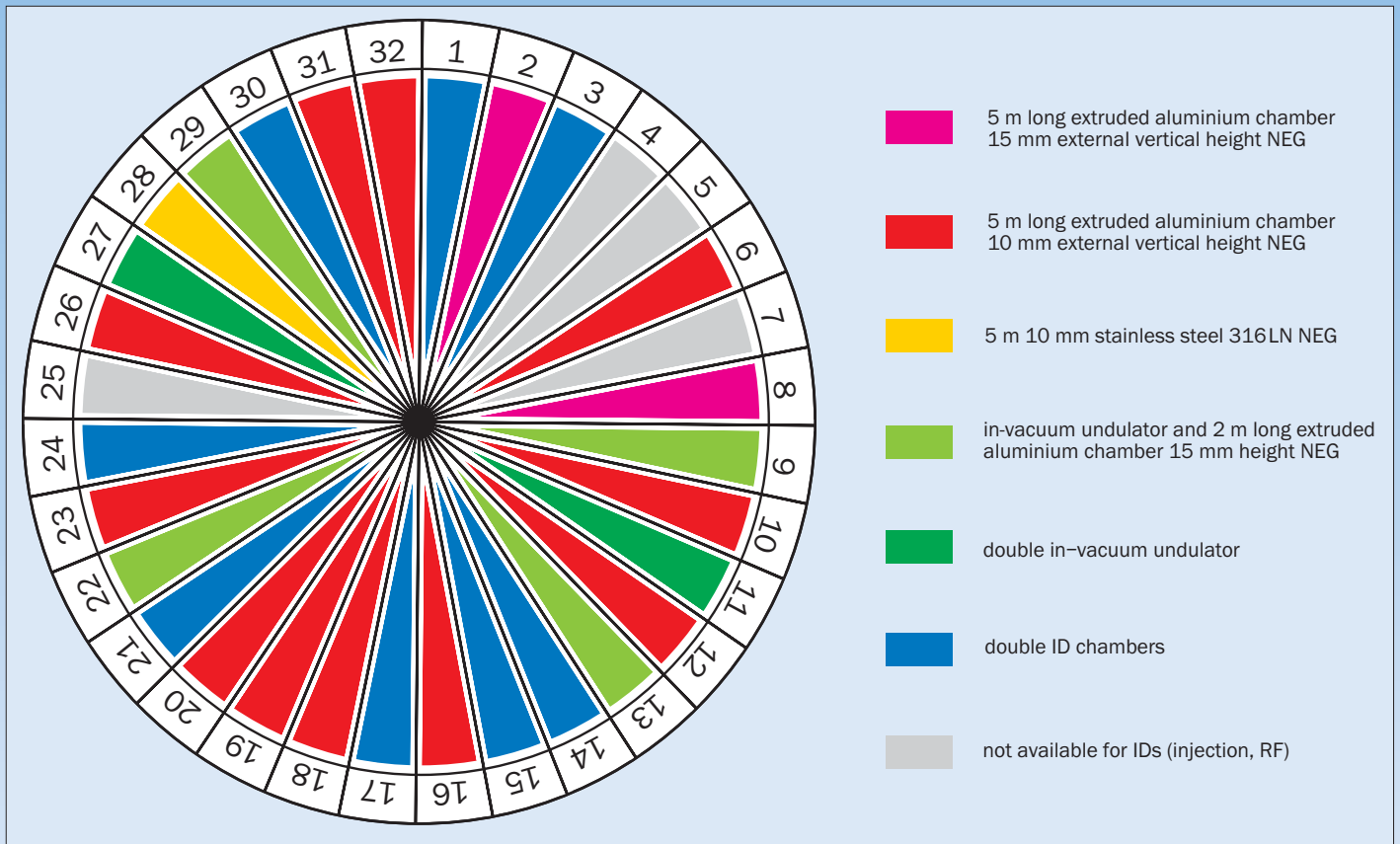

Figure 3. Range of spatial resolutions at the ESRF. A: Palaeozoic cephalopod (ID19). B: Cretaceous charophyte algae (ID19). C: Miocene rodent molar (BM5). D: Eocene primate mandible (ID19). E: Miocene primate skull (ID17). F: mandible of a Miocene hominoid (ID17).

The machine

ESRF'S NEG COATING PROJECT KEEPS GROWING



NEG-coated chambers in the storage ring. Some 80 m out of the 140 m available for the installation of IDs are taken by NEG-coated chambers.

The ESRF is the first organization other than CERN to take advantage of the non-evaporable getter thin film.

One of the major discoveries of recent years in the field of ultra-high vacuum (UHV) technology for particle accelerators has been that of the non-evaporable getter (NEG) thin film. Its discovery – a spin-off from the research that has led CERN to coating with niobium tens of superconducting RF cavities for LEP in the early 1990s – was soon recognized as being a potential breakthrough for particle accelerators. The final dream of the vacuum engineer of pumping the residual-gas molecules “at the source” had finally come true.

Without going into too much detail, it can be said that any oxide layer present on the surface of a vacuum chamber that has been exposed to air is detrimental to reaching a good vacuum. Thin films of elements belonging to the 4th and 5th group of the atomic table have a high oxygen solubility limit. On heating a NEG film to a suitable temperature of the order of few hundred degrees centigrade (a process called activation), any oxygen, nitrogen and carbon layers on the sur-

face are dissolved into the bulk of the NEG.

NEG films behave as getters (i.e. they pump most gas species normally present under UHV conditions). Hydrogen is pumped reversibly. A particular combination of three elements – titanium, zirconium and vanadium – reaches full activation at a temperature of only 180 °C, which is compatible with the use of common aluminium alloys as the material for the vacuum chamber.

For a 5 m long chamber, the NEG film is deposited by sputtering three cathodes – each one made by twisting one 0.5 mm thick wire of each material – along the chamber, which is placed in a vertical position. The cathodes are electrically insulated from the chamber, a voltage of a few hundred volts is applied to them and an inert gas – krypton – is leaked into the system at a stable pressure of the order of 5×10^{-2} mbar. A solenoidal magnetic field is applied externally to the chamber to trap the discharge and favour the ionization of krypton atoms, which do the sputtering. Once the discharge becomes stable, currents of a few tens of milliamps are drawn by each cathode. A typical NEG film is 0.5–1 µm thick and has good adhesion to the substrate material.

An NEG-coating facility has been established at the ESRF by the Vacuum Group. Two chambers, each up to 5.6 m in length, can be coated at the same time on two separate "towers". The first tower is equipped with a 1 m long sole-noid; the second with two. A dedicated control system has been developed so that the coating process runs unattended most of the time.

The NEG Coating Team is made up of five technicians, two engineers working part time on the project and additional help from trainees at the ESRF, but just about all of the Vacuum Group staff have at one time or another worked for the NEG-coating project. Since the beginning of the programme the ESRF has received requests for coating from many laboratories worldwide.

For the past few years, at least one NEG-coated ID chamber has been installed in the storage ring at each shutdown. This has allowed the operation of a number of ID beamlines with low Bremsstrahlung (BS) emission while reducing the ID magnetic gap from 16 to 11 mm. This has resulted in an increase in the photon energy and/or tunability range of the undulator radiation as well as an increase in brilliance. In parallel, a detailed experimental study of the wake field produced by an electron beam when traversing a long narrow aperture chamber shows that no difficulty is encountered. Bremsstrahlung dose rates versus integrated current are regularly recorded in the ID6 straight section on every new coated chamber.

As a new development, during 2005 two 3.5 m long quadrupole chambers have been coated, one using the SOLEIL aluminium extrusion that has been designed for SOLEIL and one using an advanced concept, characterized by an elliptical cross-section of only 30 x 20 mm². Both have performed extremely well in the storage ring in terms of prompt vacuum conditioning times and low BS levels. As a result it has become clear that a "pumpless" solution for the vacuum chamber of light sources is now possible, where a sufficiently low pressure is obtained by using NEG-coated chambers, with only few lumped pumps being necessary at high-desorption locations, such as crotch absorbers. This has raised considerable interest from many laboratories at a recent workshop dedicated to vacuum in light sources.

Acknowledgements

Our thanks go to the NEG Coating Team, Vacuum Group, TS Building and Infrastructure Group, TS Mechanical Engineering Group, Machine Division and Safety Group.

M HAHN, R KERSEVAN, Vacuum Group, Technical Services Division, ESRF

Experience Matters

For 40 years, A&N Corporation's high vacuum components have been designed to the standards required by industrial and academic users involved with:

- Thin Film Deposition
- Surface Analysis
- Laser Devices
- Cryogenics
- Aerospace
- Semiconductors

www.ancorp.com

WORLDWIDE:
A&N CORPORATION HEADQUARTERS
 Phone: +1 352 528 4100
 Fax: +1 352 528 3441
sales@ancorp.com

EUROPE:

LEWVAC, UK
 Phone: +44 (0)1273 487448
 Fax: +44 (0)1273 476246
sales@lewwac.co.uk

VAQTEC-SCIENTIFIC, GERMANY
 Phone: +49 (0)30 7871 3158
 Fax: +49 (0)30 7871 3159
sales@vaqtec-scientific.com

VAQTEC S.R.L., ITALY
 Phone: +39 0171 66507
 Fax: +39 0171 64578



High Vacuum Components
 SINCE 1965



Custom multi-element Si(Li) x-ray detectors for Synchrotron applications

Multi-functional:

high resolution with excellent spectral quality for μ -XRF, high rate for XAFS etc.



7 x 80mm² Si(Li) detector



13 x 50mm² Si(Li) detector

- Si(Li) crystals up to 80mm²
- Custom 'focussed' crystal designs
- Excellent resolution and peak to background ratio
- High count rate capability
- Ultra low spectral impurities
- Unique specialised collimation available
- Custom UHV chamber compatibility

Gresham Scientific Instruments Ltd sales@gsinst.com +44 1628 533060

www.gsinst.com

User's view



Not the average user. David Eisenberg uses ID13 to shed light on human diseases.

“It has been a pleasure to work with such creative and able investigators. We feel very fortunate that ESRF permitted an American research group access to this beamline.”

DAVID EISENBERG: AN UNUSUAL USER

David Eisenberg is an atypical ESRF user. He is the director of the Institute for Proteomics and Genomics at the University of California, Los Angeles (UCLA), in the US. His research on the fibrils that are present in diseases like Alzheimer's and “mad cow” disease led him and some of the members of his research team to the ESRF a year ago to measure data on ID13 that enabled them to determine the structure of an amyloid-forming peptide.

How did you learn about the ESRF?

In July 2003 I was fortunate in being able to participate in a workshop on Crete on amyloid fibres. There I enjoyed lunch with Carl Ivar Brändén, former director of research at the ESRF, and his wife, and he asked me about work. I told him that we had grown microcrystals of peptides that also form related amyloid fibrils, but that we were unable to determine their structure as a result of a lack of good X-ray data. Brändén told me about the microfocus beamline ID13 at ESRF and said that he thought that it would be a good match for our microcrystals.

Why would you fly all the way from the US to Europe to carry out experiments, and in particular on ID13—the microfocus beamline?

ESRF beamline ID13 is unique, or nearly so, in producing an X-ray focal spot that is only 4 µm in diameter, which is about the size of some of our largest crystals. But in addition to that, the facility is staffed by highly motivated scientists, including Christian Riekel and Anders Madsen. It has been a pleasure to work with such creative and able investigators. We feel very fortunate that ESRF permitted an American research group access to this beamline.

Do you use other synchrotron facilities in the world in your research?

Yes, we have had excellent experiences at NSLS and at ALS for a range of crystallographic problems, but these units do not currently have the microfocus equipment that has been developed at ESRF.

Your group collaborates with European groups and you also did your PhD in

Europe. How do you see European science compared with American science?

I love international collaboration. It emphasizes that science is truly an international undertaking. Scientists can lead the way in showing that humans can transcend their national barriers to work together. To address your question more directly, there seems to be more emphasis on building individual laboratories in the US, and more emphasis on building larger institutions in Europe (such as the ESRF and EMBL). As a result it may be easier for young scientists to get their start in the US, and it may be easier to build high-powered research units in Europe. Learning the advantages of both systems, and attempting to blend them, might help research on both sides of the Atlantic. The new Janelia Farm, which has been sponsored by the Howard Hughes Medical Institute, is such an experiment in America.

The triangle UCLA—University of Copenhagen—ESRF has already provided some results with the publication of an

article in *Nature* on the prions last June. What does it represent for the scientific community, and for society?

The initial result of this triangular collaboration is the first glimpse of the nature of intermolecular bonding in the amyloid-like state of the yeast prion, Sup35. This has quickly led to applying much the same approach to other amyloid-forming proteins and prions, including those involved in human disease.

I anticipate that the triangular collaboration will turn up even more interesting results in the coming year. It would be wonderful if this work moved forward into disease diagnostics and therapeutics, but only time will tell if it does.

“Motivated young scientists...are the engines of creativity and productivity of the lab.”

Did you want to be a scientist when you were a child or did the idea come later?

My father was a fine children’s doctor, whose hope was that I would follow him into medicine. To interest me in biomedical problems, he set me up with an old incubator and some other equipment for primitive experiments. His plan worked too well and I was turned on to science. But this would not have been enough to keep me in science. I also had several inspiring mentors, starting with Dr John Edsall, a protein biophysical chemist at Harvard, while I was an undergraduate. If I hadn’t been a researcher I would have been a doctor, as was my father, and as

is my daughter. In science, the highest ethic is to seek the truth. In medicine, the highest ethic is to relieve suffering and prolong life. In biomedical science, we have the chance to do both.

Your CV is never-ending. You have 222 publications, 28 books and reviews, and 18 popular writings, as well as several awards. You must be satisfied with your career.

The satisfaction comes mostly from working with wonderful students and colleagues, and together pressing out the frontiers of knowledge.

There are 17 people in your group. How do you find managing such a large group?

I’m not a manager. I try to recruit motivated young scientists who are interested in the problems of the lab, and then to work out a promising problem with them. They are the engines of creativity and productivity of the lab.

You seem to have lots of hobbies: cycling, music, history. With the busy life of a scientist that you lead, when do you find the free time?

My children are grown up, so there is often time for an early morning bike ride, or one at the weekend. Reading I do on the plane.

What are your scientific projects for the future?

I want to focus on the principles of interaction among proteins, including the types of interaction that we see in amyloid fibrils and prions.

FIGHTING AGAINST MODERN DISEASES

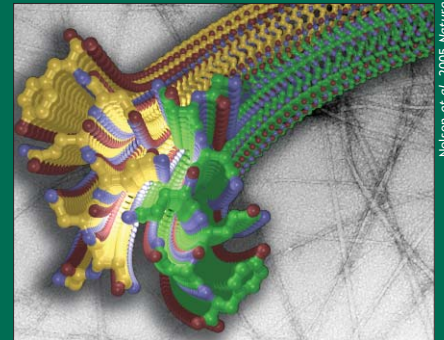

Nelson et al. 2005 Nature

The zipper structure of the amyloid fibril formed by the yeast protein.

Devastating diseases such as Alzheimer’s or the Creutzfeldt–Jakob disease (the human version of “mad cow” disease) have become a great threat to the population of the 21st century. They are known as amyloid and prion diseases, and involve a normal, functional protein converting to an abnormal, aggregated, fibrillar state.

Researchers worldwide are trying to discover more about these fibrils. Eisenberg teamed up with Christian Riek, from ID13, and recently published a breakthrough in the field in *Nature*. They revealed the structure of a region of a fibril-forming protein that may provide an insight into these diseases.

The region – a peptide – has a “molecular zipper” structure that pulls proteins together and dries them. The structure is believed to be universal in fibrils. Researchers have already started to investigate how to reverse the zipping to break down persistent fibrils or even prevent them from forming in the first place.

●
MC

Hercules Specialized Courses

Directed by: José BARUCHEL and Jean-René REGNARD

Synchrotron X-Ray Imaging

Grenoble, 21st-26th May 2006



Lecturers:

- José BARUCHEL
- Tilo BAUMBACH
- Peter CLOETENS
- Hélène ELLEAUME
- Chris JACOBSEN
- Maya KISKINOVA
- Jean SUSINI

Organized by:

- José BARUCHEL
- Nadine PETRICOLA

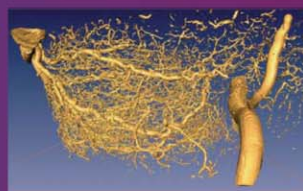
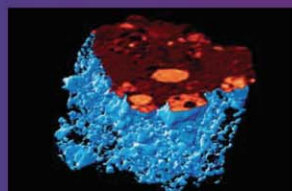

**LIMITED TO
20 PARTICIPANTS**

Introduction to the basic principles of imaging techniques (microscopy, microtomography, analyzer-based imaging, diffraction topography...) using synchrotron radiation. Theoretical and experimental aspects, and practicals on ESRF beamlines.

www.esrf.fr/NewsAndEvents/Conferences/HSC/HSC1

Registration Deadline : 1st February 2006

**FORTHCOMING
HERCULES
SPECIALIZED
COURSES**

- **8th to 13th October 2006: Structural Genomics** (Hassan BELRHALI, Dave HALL and Ed MITCHELL)
- **8th to 13th October 2006: Surfaces, Interfaces and Nanostructures** (Hartmut Till METZGER and Gilles RENAUD)



Part of the Marie Curie Conferences and Training Courses

Visiting a beamline

THE 'ANOMALOUS' BEAMLINE – ID01

In the report of the personnel audit that was carried out last year at the ESRF, the anomalous beamline ID01 was described as a “benchmark example in terms of organization and motivation”.



The ID01 team. Left to right: Bärbel Krause, Marie-Ingrid Richard, Alejandro Alija, Rajivsingh Mundboth, Vicente Solé, Lucien Petit, Christian Mocuta, Hamid Djazouli, Dina Carbone, Peter Boesecke and Till Metzger. Missing: Roland Taffut.

At this beamline, where research is focused on the nanoworld, everyone has a voice to express their opinion about any issue. This open communication, together with a great team spirit, makes the young ID01 team enthusiastic about its beamline.

“When it comes to elastic X-ray scattering, you can do almost everything at ID01,” explained Till Metzger, the scientist in charge. The range of possible techniques is very wide: anomalous scattering, SAXS, WAXS, grazing incident techniques, reciprocal space mapping, etc. This attracts a user community from very different fields of science. The scope of materials ranges from the amorphous state, polymers, microfluids and thin films to crystalline materials, especially semiconductor heterostructures. Despite carrying out very different user experiments, the mission of ID01 is to work in nanoscience and develop techniques to study nanostructured materials. “The nanoscale is not just another step in the miniaturization of matter; it is a length-scale at which properties of materials change and can therefore even be tailored artificially for functional purposes,”

clarified Metzger. Today “nano” has become such a trendy prefix in science and industry that it is easy to find collaborations with universities and companies. ID01 has also participated in EU projects and collaborates with organizations like the Max–Planck Institute in Stuttgart, Germany, and the University of Linz, Austria.

All of this work is carried out by a multinational and dynamic young team of postdoctoral researchers, scientists, a beamline operations manager, a technician and trainees. “When you come to the ESRF you know this is not a holiday and that there will be a big workload,” explained Dina Carbone, a postdoctoral researcher on ID01 for the last year. “However, when I arrived I had a pleasant surprise: I thought straightaway that there was a beautiful atmosphere in the group and this definitely compensates for the stress.”

As on other beamlines, the team gets together for group meetings and has lunch together when possible. However, on ID01 there are special features. The distribution of local contact work is done by discussion rather than delegation. “If there is a team of users working on a subject that interests me especially, I take that group. We really decide all together,” said Cristian Mocuta, the beamline scientist.

Alejandro Alija, a trainee in the group for the last month, gave his opinion of his first impressions of the beamline: “Everything really goes like clockwork.” The reason for this has to be found not only in the team but also in the head of the team, Till Metzger. “He gets in touch with all of our users, even if he is not the local contact, and that is so much appreciated that users sometimes leave presents for both the local contact and for Till,” explained Carbone.

The team spirit is also evident in the relationship of Hamid Djazouli, the technician, with the rest of the team. “He’s not just a technician,” said Cristian Mocuta. “He is curious about how the beamline functions, so we like to tell him about it and involve him in tasks like the set-up of an experiment, which is not really a technician’s work.”

To perform good science a positive team spirit is a prerequisite, where people are willing to help each other. Also the beamline must perform reliably. ID01 runs very smoothly, with modular set-ups for different experiments, but Metzger is already thinking of future technical possibilities. He has proposed a refurbishment project to management, to combine a submicron focus size and the coherence of the beam in order to investigate the properties of nanostructures. ●

MC

Gallery of events

ESRF STUDENTS PLAY KINGS FOR A DAY AND SHOW OFF THEIR WORK

Postgraduates at the ESRF present their work, interact with colleagues and receive awards one day in October.

At the ESRF's annual Students Day in October the PhD students became "kings for a day". The youngest scientists showed their work to the rest of the staff by giving talks and presenting posters. The event is intended to "give PhD students the opportunity to increase interaction with the ESRF scientists," explained Francesco Sette, director of research.

From research on ice, to spider silk and cartilage studies and catalytic CO oxidation, PhD students at the ESRF covered all sorts of subjects in very different fields. In a series of 20 minute presentations, 12 students shared their results with the rest of the scientists at the ESRF, arousing a lot of interest, judging by the hands in the air from the audience.

The enthusiasm of the PhD students was obvious in the clip and poster session: even novice students with just a few months at the ESRF under their belt presented their first work despite their embryonic results. The poster prizes, which were awarded by Francesco Sette and Pierre Thiry, head of technical services, recognized the quality of the scientific results in two of the 29 posters that were presented. Cyril Dian from the Macromolecular Crystallography Group, was awarded a prize for his work on biosensors for nitro-toluenes. Lee Brooks from the Materials Science Group received his award for a poster on stereo-selective synthesis and the crystal structure of insect pheromones.

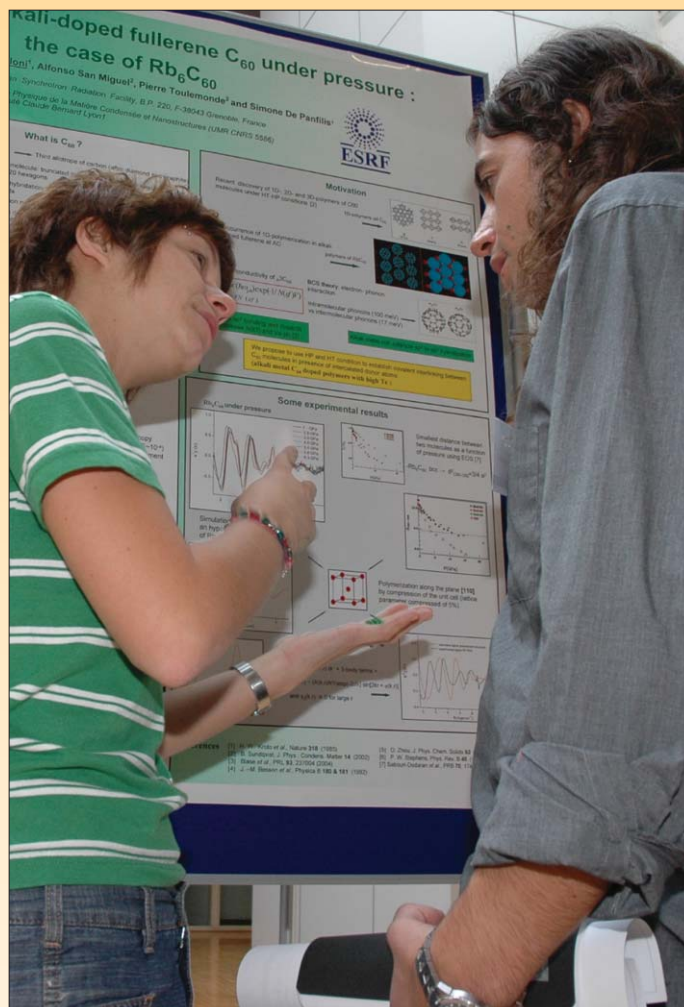

From PhD student to PhD student. Roberta Poloni explains the work behind her poster presentation to Mario Rodrigues.

Despite being the youngest and least-experienced researchers, PhD students are of great importance at the ESRF. "Their work is crucial for the advancement of science," said Sette, "and it represents an important means to develop collaborations with other institutes".

MC

WORKSHOP GETS CLOSER TO DETECTORS

This popular annual event covered a broad range of topics within the field of imaging detectors.

The ESRF hosted the 7th International Workshop on Radiation Imaging Detectors (IWoRID-7) last summer. This is held annually and always at a different location in Europe. This year the ESRF, together with the CEA-LETI, had the honour of organizing this important workshop. The event dealt with all aspects of imaging detectors, and many different

topics were covered: scintillators, semiconductors, microelectronics, interconnect technologies, the physics of imaging, high-energy physics, medical imaging, space research, fusion research and, of course, synchrotron radiation research. This year's workshop had a record number of 150 participants and it featured 13 invited and 32 contributed talks as well as 40 poster presentations. IWoRID-8 will be held in Pisa next year.

HEINZ GRAAFSMA

NUCLEAR RESONANCE SCATTERING IN SYNCHROTRON RADIATION CELEBRATES 20 YEARS

A symposium on NRSSR celebrated the early origins, development and future of an invaluable technique.

Nuclear resonance scattering with synchrotron radiation (NRSSR) was a dream 30 years ago, impelling several research groups worldwide to start working enthusiastically on its realization. The first contributions to the "Blue book" for the ESRF project were just visions without any experimental proof. Funding agencies had to wait patiently until 1985 when the first paper was published on "Nuclear Bragg diffraction of synchrotron radiation in yttrium iron garnet" (1985 *PRL* 54 835). This dream has now become reality and NRSSR is widely used today as a valuable and multifaceted spectroscopic method in various fields.

The symposium on NRSSR summarized today's achievements, the methods that have been developed and, in particular, the spectroscopies that have been established at the ESRF, APS and SPring-8. Furthermore, applications where the technique significantly contributes to the understanding of problems most relevant today were highlighted with the vision of future developments.

It was fortunate that the first scientists involved in this field joined the event and their presence and presentations were a reminder of the early days in nuclear Bragg scattering, nuclear forward scattering and nuclear inelastic scattering. Later methodological developments and recent scientific highlights were covered by relevant experts. ●

RUDOLF RÜFFER

COHERENCE WORKSHOP

The fifth workshop in the series addresses coherence and the need for more synchrotron radiation facilities.

The availability of coherent beams has had a tremendous impact on imaging and scattering experiments with X-rays, and on experiments with electrons and neutrons. More than 100 researchers from four different continents met last summer on the island of Porquerolles, France, to discuss new methods exploiting coherence and phase information.

The Coherence 2005 workshop addressed open problems and challenges in this rapidly evolving field and was a continuation of previous meetings (Berkeley 2001; Cairns, Australia, 2003; and Berkeley 2003). Many of the subjects that were discussed are at the heart of the motivation for building new synchrotron radiation facilities and X-ray free electron lasers. Each workshop day was devoted to one of the three main topics: phase retrieval, X-ray photon correlation spectroscopy and coherent diffraction imaging.

The event was organized by the ESRF, Swiss Light Source and DESY, and it benefited from support from the European I3 project IA-SFS under the FP6 Structuring the European Research Area Programme. A follow-up meeting is planned for 2007 and will probably take place in California.

Abstracts, talks and a workshop booklet are available from <http://www.esrf.fr/Conferences/Coherence2005/>. ●

ANDERS MADSEN

PGT's Multi-Element Array Detectors



Customized Design Configurations

- 10 mm Si(Li)
- 30 mm Si(Li)
- 60 mm Si(Li)
- Low energy detection down to Boron (180 eV)
- Energy Resolution < 130 eV
- Excellent Peak to Background
- 14 elements or higher in customized geometries

Outstanding low energy performance and high data collection rate in one instrument!

PGT also manufactures premium Germanium, Si(Li) and Silicon Drift Detectors for BeamLine, XRF and Fundamental Physics Research

ESRF USERS' MEETING

7-8 February 2006

E-mail: useroff@esrf.fr <http://www.esrf.fr/NewsAndEvents/Events/UsersMe06-02-06/>



Caburn together with MDC in Europe

Caburn and MDC are working together to build the most complete range of Subminiature-C and D-type connectivity products available to the European scientific community.

Caburn-MDC Europe's Subminiature-C and Subminiature-D products are designed to meet industry standards. Our connectors are fitted with gold-plated pins in a variety of configurations, providing innovative solutions where space is at a premium.

We also supply a range of cables, connectors, accessories and tools to facilitate a complete solution for all your connectivity needs.

Subminiature-C

- Feedthroughs
- Cable assemblies
- Connectors

Subminiature-D

- Feedthroughs
- Cable assemblies
- Connectors

Accessories and tools

Wire cables and insulators

Custom fabrications

Our sales teams will be happy to discuss your requirements and answer any queries – please contact your local office or visit our website.

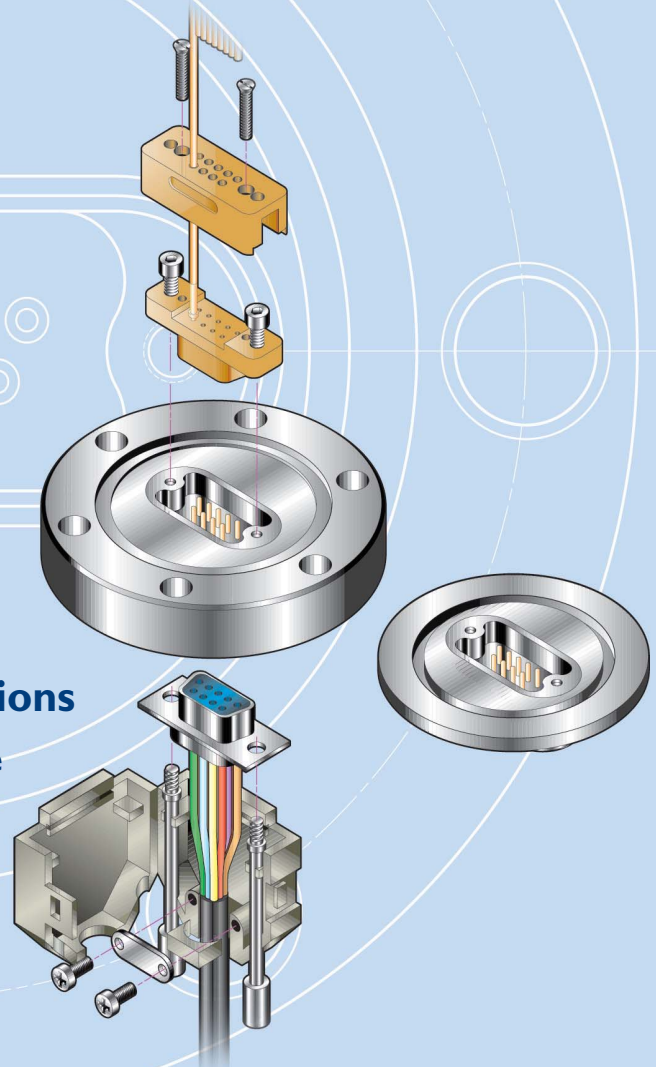

Visit our website today www.caburn.co.uk



UK 12 Horsted Square
Bellbrook Business Park
Uckfield, East Sussex TN22 1QG
Tel: +44 (0)870 428 7646
Fax: +44 (0)870 428 7647
e-mail: sales@caburn.co.uk

France 38 Place des Pavillons
69007 LYON
Tel: +33 (0)437 65 17 50
Fax: +33 (0)437 65 17 55
e-mail: info@caburn.fr